

Modulares Werkzeugsystem HW

Modular tool system HW
Système d'outils modulaire HW

Katalog Nr.
Catalogue No. | Numéro de catalogue

9.180

WENDELtools
TECHNOLOGY YOU CAN TRUST

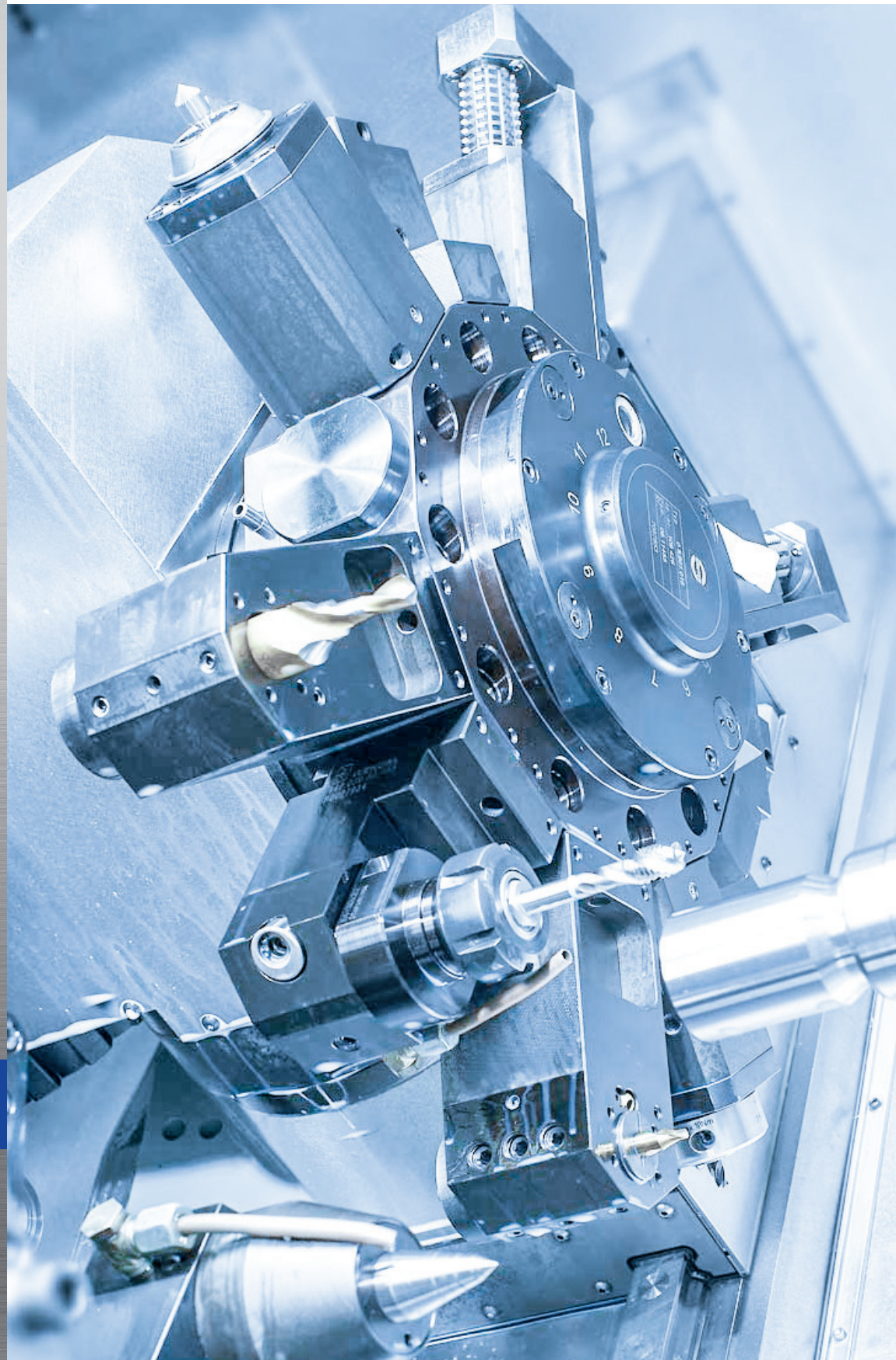

QUALITY MADE IN GERMANY

www.wendel-tools.de



Unsere Produkte erfüllen auch höchste Erwartungen

Was nutzt die beste Maschine, wenn das Werkzeug nicht mithalten kann?



Wir sind stolz darauf, unseren Kunden Werkzeugtechnologie mit bemerkenswert geringen Toleranzen bieten zu können.

Hochpräzise, angetriebene Werkzeuge, Präzisionswerkzeuge, Werkzeugsysteme und Mehrspindelköpfe für Drehzentren und Bearbeitungszentren. Ob mit oder ohne Antrieb, ob als Standardausführung oder als Sonderanfertigung.

Und damit es erst gar nicht hart auf hart kommt, werden bei uns ein Großteil der Werkzeuge in unserer eigenen Härterei einsatzgehärtet.

Hochwertige, robuste Werkzeug-Garanten für lange Werkzeugstandzeiten und eine exakte Produktion. Auf der ganzen Welt arbeiten anspruchsvolle Unternehmen mit den Qualitätswerkzeugen von **WENDELtools**.

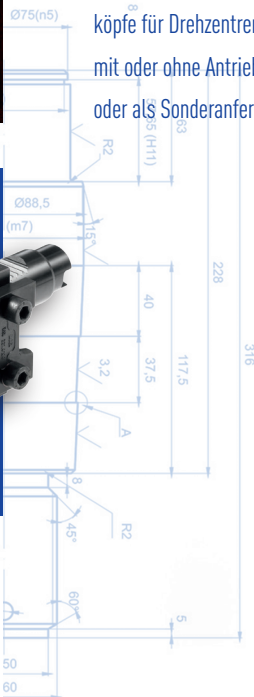

- Über 50 Jahre Erfahrung
- Kurze Produktionszeiten
- Passgenau & individuell

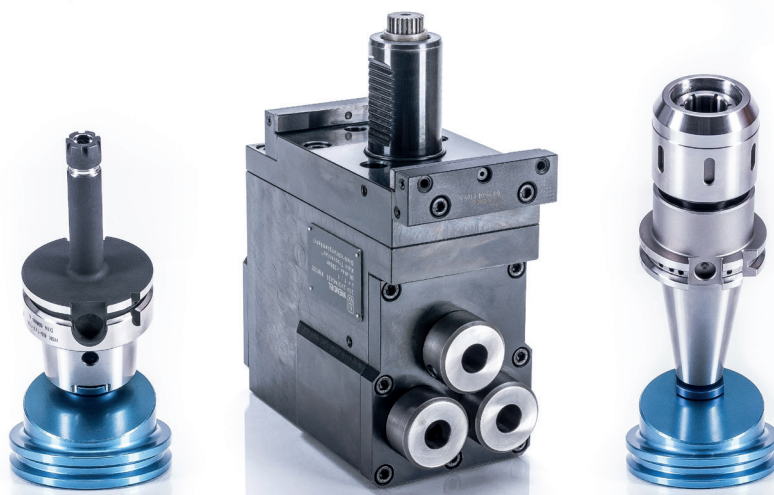

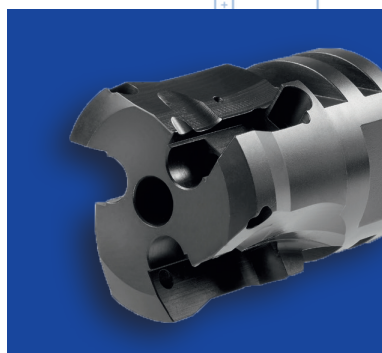

Our Products also fulfill the highest expectations

What good is the best machine if the tool can't keep up?

We are proud of the fact that we can offer our customers tool technology with remarkably small tolerances.

High precision power-driven tools, precision tools, tool systems and multi-spindle heads for lathe centers and machining centers. With or without power drive, whether as standard execution or special production. And to see that the going

never gets tough, a large portion of our tools are application-hardened in our own hardening shop.

High quality, robust tool guarantors for long tool life and precise production.

Throughout the world, demanding businesses work with quality tools by **WENDELtools**.

Nos produits répondent aussi aux attentes les plus exigeantes

À quoi bon avoir la meilleure machine si l'outillage ne suit pas?

Nous sommes fiers de pouvoir offrir à nos clients une technologie d'outillage de tolérance remarquablement faible.

Outils électriques haute précision, outils de précision, systèmes d'outils et têtes multibroches pour tours et centres d'usinage. Électriques ou non, de réalisation standard ou sur-mesure.

Et pour être sûr que les choses ne se gâtent pas, une grande partie de nos outils sont endurcis dans nos propres ateliers de trempe.

Garants d'outils de haute qualité et robustes pour des outils qui durent et une production précise. Partout dans le monde, les entreprises exigeantes travaillent avec des outils de qualité fabriqués par **WENDELtools**.

More than 50 years of experience

Short production times

Custom-fit & individual

Plus de 50 années d'expérience

Courts délais de production

Sur-mesure & individualisés

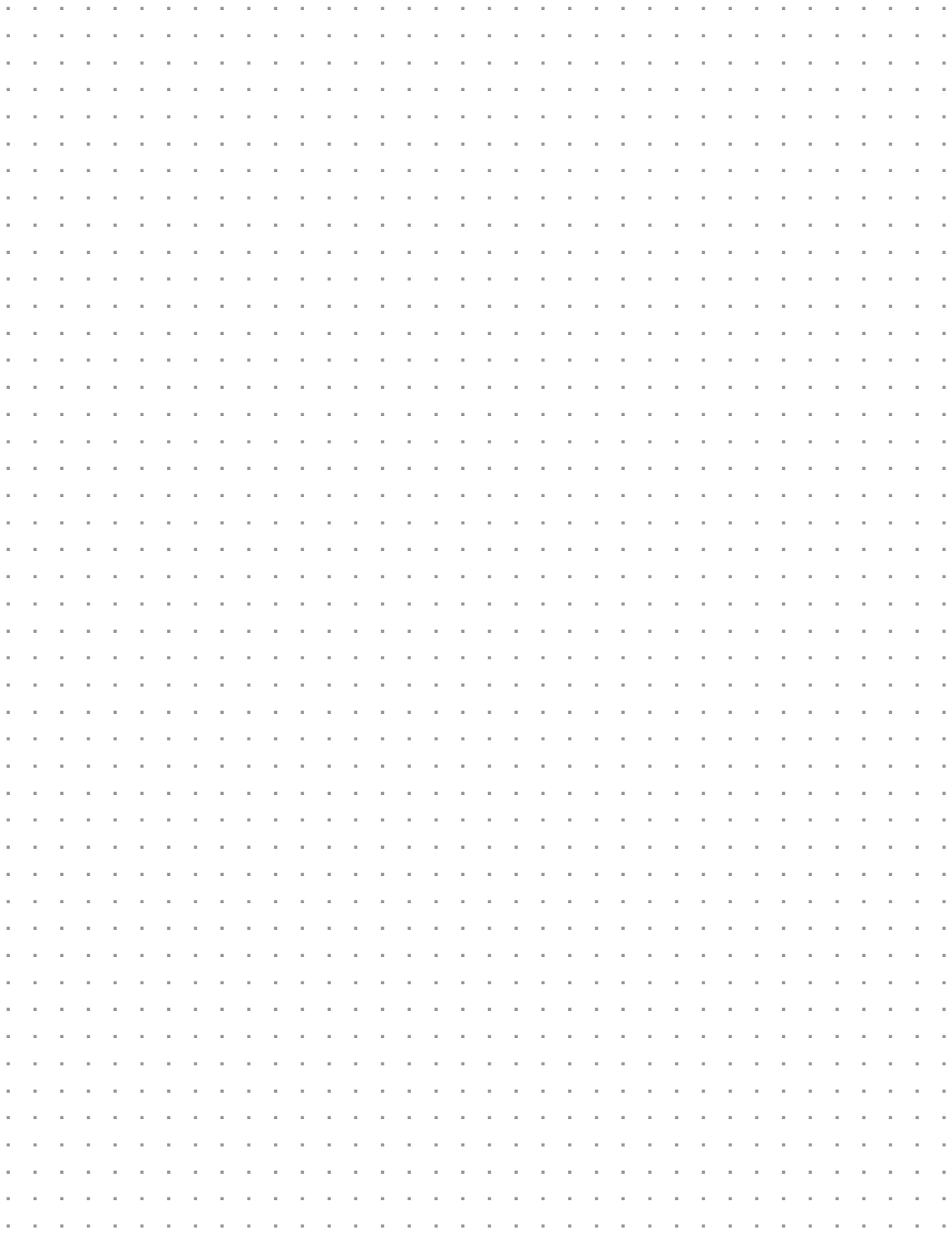

HW - Größen: HW16 / HW24 / HW34 / HW44 / HW60

HW sizes: HW16 / HW24 / HW34 / HW44 / HW60 | Taille HW: HW16 / HW24 / HW34 / HW44 / HW60

Seite | Page | Page

		Beispiele Sonderwerkzeuge: HW; BMT; Capto; CDI; HSK; BAZ	Example of special tools HW; BMT; Capto; CDI; HSK; BAZ	Exemples d'outils spéciaux : HW; BMT; Capto; CDI; HSK; BAZ	3.0
	Typ 180.0	Einstelladapter für Voreinstellgeräte	Setting adapter for presetting devices	Adaptateur de réglage pour banc de pré réglage	11.0
	Typ 127	HW-Wechseleinsätze Typ 127-114 Aufnahme DIN1835-B; Typ 127-113 Aufnahme DIN1835-E	HW-Interchangeable inserts Type 127-114 holder DIN1835-B; Type 127-113 Holder DIN1835-E	Inserts interchangeable HW Type 127-114 porte-outils DIN1835-B; Type 127-113 Porte-outils DIN 1835-E	12.0
	Typ 127	HW - Wechseleinsätze Typ 127-115 Hydrodehnaufnahme	HW-interchangeable inserts Typ 127-115 Hydraulic holder	HW - Inserts interchangeables Type 127-115 Porte-outils mandrin hydraulique	13.0
	Typ 127	HW - Wechseleinsätze Typ 127-116 ABS-NC-Aufnahme	HW-interchangeable inserts Typ 127-116 ABS-NC-holder	HW - Inserts interchangeables Type 127-116 Porte-outils ABS-NC	14.0
	Typ 127	HW - Wechseleinsätze Typ 127-121 - Aufnahme Spannzange DIN 6499	HW-interchangeable inserts Typ 127-121 - Holder Draw-in attachment DIN 6499	HW - Inserts interchangeables Type 127-121 porte-outils Pince de serrage DIN 6499	15.0
	Typ 127	HW - Wechseleinsätze Typ 127-125 Fräseraufnahme	HW-interchangeable inserts Typ 127-125 Milling cutter	HW - Inserts interchangeables Type 127-125 Porte-outils fraise	16.0
	Typ 127	HW - Wechseleinsätze Typ 127-801 Spannzangenfutter Softsynchrosystem Emuge	HW - interchangeable inserts Typ 127-801 Collet chuck Soft synchro system Emuge	HW - Inserts interchangeables type 127-801 mandrin porte-fraises Système Soft-Synchro Emuge	17.0
	Typ 180.0	HW-Werkzeugaufnahme axial	HW-tool holder axial	Porte-outils HW axial	18.0
	Typ 180.0	HW-Werkzeugaufnahme axial 2-fach	HW-tool holder axial 2x	Porte-outils HW axial double	19.0
	Typ 180.2	HW-Werkzeugaufnahme 90° - abgewinkelt	HW-tool holder 90° - angled	Porte-outils HW 90° - coudé	20.0
	Typ 180.2	HW-Werkzeugaufnahme 90° - abgewinkelt 2-fach	HW-tool holder 90° - angle 2x	Porte-outils HW 90° - coudé 2 fois	21.0

		Übersicht Angetriebene Werkzeuge HW-Wechselsystem	Summary of driven tools, HW changing system	Présentation Outils motorisés Système HW	23.0
	DIN5480	Axial- Bohr- und Fräskopf Desaxial- Bohr- und Fräskopf Radial- Bohr- und Fräskopf	Axial drilling and milling head Desaxial drilling and milling head Radial drilling and milling head	Tête de perçage-fraisage axial Tête de perçage-fraisage désaxial Tête de perçage-fraisage radial	25.0
	DIN5482	Axial- Bohr- und Fräskopf Radial- Bohr- und Fräskopf	Axial drilling and milling head Radial drilling and milling head	Tête de perçage-fraisage axial Tête de perçage-fraisage radial	27.0
	Index	Axial- Bohr- und Fräskopf Desaxial- Bohr- und Fräskopf Radial- Bohr- und Fräskopf	Axial drilling and milling head Desaxial drilling and milling head Radial drilling and milling head	Tête de perçage-fraisage axial Tête de perçage-fraisage désaxial Tête de perçage-fraisage radial	28.0
	Moriseiki NL-Serie	Axial- Bohr- und Fräskopf Radial- Bohr- und Fräskopf	Axial drilling and milling head Radial drilling and milling head	Tête de perçage-fraisage axial Tête de perçage-fraisage radial	30.0
	DIN1809	Axial- Bohr- und Fräskopf Radial- Bohr- und Fräskopf	Axial drilling and milling head Radial drilling and milling head	Tête de perçage-fraisage axial Tête de perçage-fraisage radial	31.0
	Haas	Axial- Bohr- und Fräskopf Radial- Bohr- und Fräskopf	Axial drilling and milling head Radial drilling and milling head	Tête de perçage-fraisage axial Tête de perçage-fraisage radial	32.0
	Okuma	Axial- Bohr- und Fräskopf	Axial drilling and milling head	Tête de perçage-fraisage axial	33.0
	Doosan	Axial- Bohr- und Fräskopf Radial- Bohr- und Fräskopf	Axial drilling and milling head Radial drilling and milling head	Tête de perçage-fraisage axial Tête de perçage-fraisage radial	34.0
	EMAG BMT	Axial- Bohr- und Fräskopf Radial- Bohr- und Fräskopf	Axial drilling and milling head Radial drilling and milling head	Tête de perçage-fraisage axial Tête de perçage-fraisage radial	35.0
	Typ 180	HW - Lagersystem Grundaufnahme und Bundbuchsen	HW - storage system Basic holder and flange sleeve	Système de paliers HW Porte-outils de base et bagues à collerette	37.0
	Typ 127	HW-Verschlußbolzen	HW-sealing bolts	Boulon de verrouillage HW	38.0

Beispiele für Werkzeuge mit HW-Aufnahme

Examples of tools with HW mounting | Exemples d'outils avec logement HW

	<p>280.440-A6680W</p> <ul style="list-style-type: none"> ▪ Winkel-Fräskopf HW44 ▪ Mit festem Winkel -6° ▪ Index W-Verzahnung 	<p>280.440-A6680W</p> <ul style="list-style-type: none"> ▪ Angle milling head HW44 ▪ With fixed angle -6° ▪ Index W interlock 	<p>280.440-A6680W</p> <ul style="list-style-type: none"> ▪ Tête de fraisage à renvoi d'angle HW44 ▪ À angle fixe -6° ▪ Index Denture W
	<p>280.440-A6680W</p> <ul style="list-style-type: none"> ▪ Winkel-Fräskopf HW44 ▪ Mit festem Winkel - 20° ▪ i = 1 : 2 	<p>280.440-A6680W</p> <ul style="list-style-type: none"> ▪ Angle milling head HW44 ▪ With fixed angle - 20° ▪ i = 1 : 2 	<p>280.440-A6680W</p> <ul style="list-style-type: none"> ▪ Tête de fraisage à renvoi d'angle HW44 ▪ À angle fixe - 20° ▪ i = 1 : 2
	<p>280.550-A6116</p> <ul style="list-style-type: none"> ▪ Desaxialer-Fräskopf HW34 ▪ i = 1 : 3 	<p>280.550-A6116</p> <ul style="list-style-type: none"> ▪ Offset milling head HW34 ▪ i = 1 : 3 	<p>280.550-A6116</p> <ul style="list-style-type: none"> ▪ Tête de fraisage désaxial HW34 ▪ i = 1 : 3
	<p>680.110-A6223</p> <ul style="list-style-type: none"> ▪ Doppel-Einkel-Fräskopf HW44 	<p>680.110-A6223</p> <ul style="list-style-type: none"> ▪ Dual angle milling head HW44 	<p>680.110-A6223</p> <ul style="list-style-type: none"> ▪ Tête de fraisage à renvoi d'angle double HW44

Weitere Ausführungen nach Kundenwunsch auf Anfrage | Additional configurations according to customer requirements if requested | D'autres exécutions possibles selon les souhaits du client sur demande
 Das HW-System ist patentrechtlich geschützt! | The HW system is patent-protected! | Le système HW est protégé par brevet.

Beispiele für Werkzeuge mit BMT-Schnittstelle

Example of tools with BMT interface | Exemples d'outils avec interface BMT

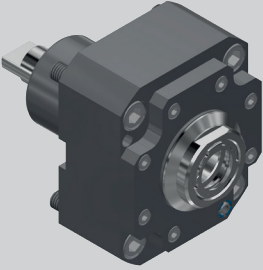
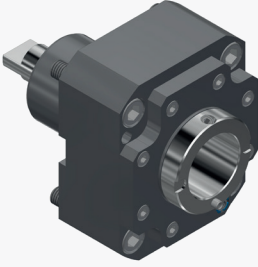
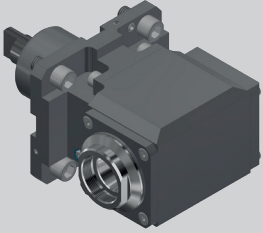
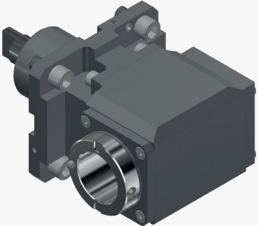
	<p>221.060.20.806</p> <ul style="list-style-type: none"> ▪ BMT - Axial Bohr- und Fräskopf ▪ Moriseiki NL-Serie BMT 60 - ER32 	<p>221.060.20.806</p> <ul style="list-style-type: none"> ▪ BMT - Axial bore- and milling head ▪ Moriseiki NL series BMT 60 - ER32 	<p>221.060.20.806</p> <ul style="list-style-type: none"> ▪ Tête de perçage-fraisage axial BMT ▪ Série NL Mori Seiki BMT 60 - ER32
	<p>280.060.44.801</p> <ul style="list-style-type: none"> ▪ Moriseiki NL-Serie BMT 60 - HW44 	<p>280.060.44.801</p> <ul style="list-style-type: none"> ▪ Moriseiki NL Series BMT 60 - HW44 	<p>280.060.44.801</p> <ul style="list-style-type: none"> ▪ Série NL Mori Seiki BMT 60 - HW44
	<p>221.260.20.806</p> <ul style="list-style-type: none"> ▪ BMT - Winkel Bohr- und Fräskopf ▪ Moriseiki NL-Serie BMT 60 - ER32 	<p>221.260.20.806</p> <ul style="list-style-type: none"> ▪ BMT - Angle bore- and milling head ▪ Moriseiki NL series BMT 60 - ER32 	<p>221.260.20.806</p> <ul style="list-style-type: none"> ▪ Tête de perçage-fraisage à renvoi d'angle BMT ▪ Série NL Mori Seiki BMT 60 - ER32
	<p>280.260.44.801</p> <ul style="list-style-type: none"> ▪ BMT - HW - Winkel Bohr- und Fräskopf ▪ Moriseiki NL-Serie BMT 60 - HW44 	<p>280.260.44.801</p> <ul style="list-style-type: none"> ▪ BMT - HW - Angle bore- and milling head ▪ Moriseiki NL series BMT 60 - HW44 	<p>280.260.44.801</p> <ul style="list-style-type: none"> ▪ Tête de perçage-fraisage à renvoi d'angle HW BMT ▪ Série NL Mori Seiki BMT 60 - HW44

BMT - Standardwerkzeuge siehe Katalog 10 | BMT standard tools, see catalogue 10 | Outils standards BMT, voir catalogue 10

Sonderausführungen auf Anfrage | Special designs on request | Modèles spéciaux sur demande

Beispiele für Werkzeuge mit BMT-Schnittstelle

Example of tools with BMT interface | Exemples d'outils avec interface BMT

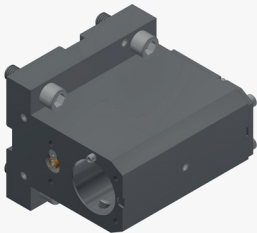
	<p>102.060.25.805</p> <ul style="list-style-type: none">▪ BMT - Werkzeughalter▪ Moriseiki NL-Serie BMT 60 - H1=25 mm	<p>102.060.25.805</p> <ul style="list-style-type: none">▪ BMT Tool holder▪ Moriseiki NL series BMT 60 - H1 = 25 mm	<p>102.060.25.805</p> <ul style="list-style-type: none">▪ Porte-outil BMT▪ Série NL Mori Seiki BMT 60 - H1=25 mm
	<p>180.260.44.805</p> <ul style="list-style-type: none">▪ BMT - HW Werkzeugaufnahme▪ Moriseiki NL-Serie BMT 60 - HW44	<p>180.260.44.805</p> <ul style="list-style-type: none">▪ BMT - HW tool mounting▪ Moriseiki NL series BMT 60 - HW44	<p>180.260.44.805</p> <ul style="list-style-type: none">▪ Logement d'outil BMT - HW▪ Série NL Mori Seiki BMT 60 - HW44

BMT - Standardwerkzeuge siehe Katalog 10 | BMT standard tools, see catalogue 10 | Outils standards BMT, voir catalogue 10

Sonderausführungen auf Anfrage | Special designs on request | Modèles spéciaux sur demande

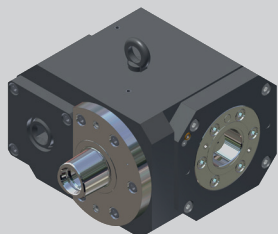

276.776-A6324

- CAPTO - Winkelfräskopf
- CAPTO - C6 / C6
- IK - 80 bar

276.776-A6324

- CAPT - Angle milling head
- CAPTO - C6 / C6
- IC - 80 bar

276.776-A6324

- Tête de fraisage à renvoi d'angle CAPTO
- CAPTO - C6 / C6
- IK - 80 bar

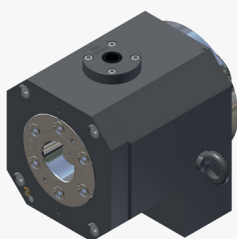

276.076-A6323

- CAPTO - Axialfräskopf
- CAPTO - C6 / C6
- IK - 80 bar

276.076-A6323

- CAPTO - Axial milling head
- CAPTO - C6 / C6
- IC - 80 bar

276.076-A6323

- Tête de fraisage axial CAPTO
- CAPTO - C6 / C6
- IK - 80 bar

	<p>253.068-A6073</p> <ul style="list-style-type: none"> ▪ Axial Bohr- und Fräskopf ▪ CDI 68 - DIN 5480 ▪ HSK - 40C ▪ IK - MMS 	<p>253.068-A6073</p> <ul style="list-style-type: none"> ▪ Axial bore- and milling head ▪ CDI 68 - DIN 5480 ▪ HSK - 40C ▪ IC - min. qty. Lube 	<p>253.068-A6073</p> <ul style="list-style-type: none"> ▪ Tête de perçage-fraisage axial ▪ CDI 68 - DIN 5480 ▪ HSK - 40C ▪ IK - VMG
	<p>253.080-A7259C</p> <ul style="list-style-type: none"> ▪ Axial Bohr- und Fräskopf ▪ CDI 80 - DIN 5480 ▪ HSK - 63 C ▪ IK - 80 bar 	<p>253.080-A7259C</p> <ul style="list-style-type: none"> ▪ Axial bore- and milling head ▪ CDI 80 - DIN 5480 ▪ HSK - 63 C ▪ IC - 80 bar 	<p>253.080-A7259C</p> <ul style="list-style-type: none"> ▪ Tête de perçage-fraisage axial ▪ CDI 80 - DIN 5480 ▪ HSK - 63 C ▪ IK - 80 bar
	<p>275.480-A7481C</p> <ul style="list-style-type: none"> ▪ Winkel Bohr- und Fräskopf ▪ CDI 80 - DIN 5480 ▪ CAPTO C5 ▪ IK - 80 bar 	<p>275.480-A7481C</p> <ul style="list-style-type: none"> ▪ Angle bore- and milling head ▪ CDI 80 - DIN 5480 ▪ CAPTO C5 ▪ IC - 80 bar 	<p>275.480-A7481C</p> <ul style="list-style-type: none"> ▪ Tête de perçage-fraisage à renvoi d'angle ▪ CDI 80 - DIN 5480 ▪ CAPTO C5 ▪ IK - 80 bar
	<p>253.468-A5629C</p> <ul style="list-style-type: none"> ▪ Winkel Bohr- und Fräskopf ▪ CDI 68 - Zweiflach ▪ HSK - 32 C ▪ IK - 80 bar 	<p>253.468-A5629C</p> <ul style="list-style-type: none"> ▪ Angle bore- and milling head ▪ CDI 68 - Two-fold ▪ HSK - 32 C ▪ IC - 80 bar 	<p>253.468-A5629C</p> <ul style="list-style-type: none"> ▪ Tête de perçage-fraisage à renvoi d'angle ▪ CDI 68 - Double ▪ HSK - 32 C ▪ IK - 80 bar

	<p>221.163-A6645</p> <ul style="list-style-type: none"> ▪ Winkelfräskopf ▪ Spannange DIN 6499-ER11 ▪ Schnittstelle Maschine HSK 63-A 	<p>221.163-A6645</p> <ul style="list-style-type: none"> ▪ Angle milling head ▪ Collet chuck DIN 6499-ER11 ▪ Machine interface HSK 63-A 	<p>221.163-A6645</p> <ul style="list-style-type: none"> ▪ Tête de fraisage à renvoi d'angle ▪ Pince de serrage DIN 6499-ER11 ▪ Interface machine HSK 63-A
	<p>675.250-A5935</p> <ul style="list-style-type: none"> ▪ Winkelfräskopf ▪ Aufnahme für Sonderfräser ▪ Schnittstelle Maschine HSK 50-B ▪ Index G300 Frässpindel 	<p>675.250-A5935</p> <ul style="list-style-type: none"> ▪ Angle milling head ▪ Mounting for special miller ▪ Machine interface HSK 50-B ▪ Index G300 Milling spindle 	<p>675.250-A5935</p> <ul style="list-style-type: none"> ▪ Tête de fraisage à renvoi d'angle ▪ Logement pour fraises spéciales ▪ Interface machine HSK 50-B ▪ Index G300 Porte-fraise

	<p>671.110-A5093</p> <ul style="list-style-type: none"> ▪ Winkelfräskopf mit 12,5° festem Winkel ▪ Spannzangenaufnahme DIN 6499-ER40 ▪ IK - 80 bar ▪ Schnittstelle Maschine HSK 100-A 	<p>671.110-A5093</p> <ul style="list-style-type: none"> ▪ Angle milling head with 12.5° fixed angle ▪ Collet chuck DIN 6499-ER40 ▪ IC - 80 bar ▪ Machine interface HSK 100-A 	<p>671.110-A5093</p> <ul style="list-style-type: none"> ▪ Tête de fraisage à renvoi d'angle à angle fixe 12,5° ▪ Logement pour pince de serrage DIN 6499-ER40 ▪ IK - 80 bar ▪ Interface machine HSK 100-A
	<p>675.110-A5401</p> <ul style="list-style-type: none"> ▪ Doppelwinkelfräskopf ▪ Aufnahme für Sonderfräser ▪ Kühlmittelzufuhr über 4 Düsen ▪ Schnittstelle Maschine HSK 100-A ▪ Mit 4-fach Hydraulik-Verspannung 	<p>675.110-A5401</p> <ul style="list-style-type: none"> ▪ Dual-angle milling head ▪ Mounting for special miller ▪ Coolant via 4 nozzles ▪ Machine interface HSK 100-A ▪ With 4-fold tensioning 	<p>675.110-A5401</p> <ul style="list-style-type: none"> ▪ Tête de fraisage à renvoi d'angle double ▪ Logement pour fraises spéciales ▪ Alimentation Réfrigérant par 4 buses ▪ Interface machine HSK 100-A ▪ Avec quadruple serrage hydraulique
	<p>225.951-A6747</p> <ul style="list-style-type: none"> ▪ Doppelwinkelfräskopf ▪ Aufnahme für Sonderfräser ▪ Kühlmittelzufuhr über 4 Düsen ▪ Schnittstelle Maschine SK-B50 ▪ Mit 3-fach Hydraulik-Verspannung 	<p>225.951-A6747</p> <ul style="list-style-type: none"> ▪ Dual-angle milling head ▪ Mounting for special miller ▪ Coolant via 4 nozzles ▪ Machine interface SK-B50 ▪ With 3-fold hydraulic tensioning 	<p>225.951-A6747</p> <ul style="list-style-type: none"> ▪ Tête de fraisage à renvoi d'angle double ▪ Logement pour fraises spéciales ▪ Alimentation Réfrigérant par 4 buses ▪ Interface machine SK-B50 ▪ Avec triple serrage hydraulique

A large grid of small dots for taking notes, covering most of the page area.

Typ 180 Einstell-Adapter

Typ 180 Setting-Adapter | Type 180 Adaptateur de réglage



- Zur Voreinstellung der HW-Wechseleinsätze
 - Als Montagehilfe beim Werkzeugwechsel
 - Weitere Ausführungen nach Kundenwunsch auf Anfrage
- For presetting the HW-interchangeable inserts
 - Used as a mounting aid during tool change
 - Additional configurations according to customer requirements if requested
- Pour le pré réglage des inserts interchangeables HW
 - Comme aide au montage pendant le changement d'outils
 - D'autres exécutions possibles selon les souhaits du client sur demande

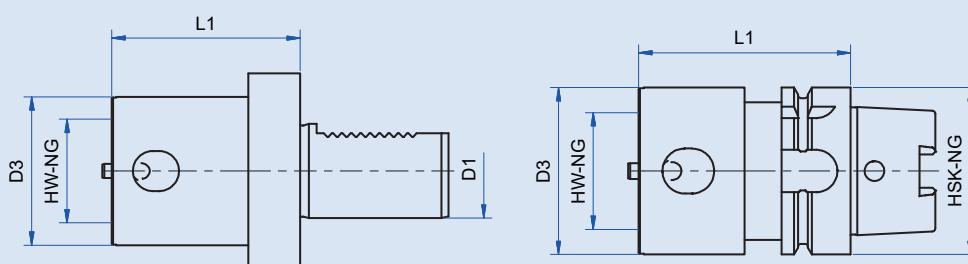

D1	HSK NG	HW NG	D3	L1	A-Nr.	Bestell-Nr. Order No. No. de commande
40		16	33	80		180.040.16.080
40		24	35	80		180.040.24.080
40		34	54	80	A5627	180.040.34.080
40		44	63	80	A5494	180.040.44.080
50		44	63	80		180.050.44.080
-	63-A	16	33	80		650.163.16.080
-	63-A	24	35	80		650.163.24.080
-	63-A	34	35	80		650.163.34.080
-	63-A	44	35	80	A5493	650.163.44.080



- DIN 1835 - Form B (Weldon) = 127.- - - - .114
 - DIN 1835 - Form E (Whistle Notch) = 127.- - - - .113
 - Weitere Ausführungen nach Kundenwunsch auf Anfrage
- *DIN 1835 - Form B (Weldon) = 127.- - - - .114*
 - *DIN 1835 - Form E (Whistle Notch) = 127.- - - - .113*
 - *Additional configurations according to customer requirements if requested*
- *DIN 1835 - Forme B (Weldon) = 127.- - - - .114*
 - *DIN 1835 - Forme E (Whistle Notch) = 127.- - - - .113*
 - *D'autres exécutions possibles selon les souhaits du client sur demande*

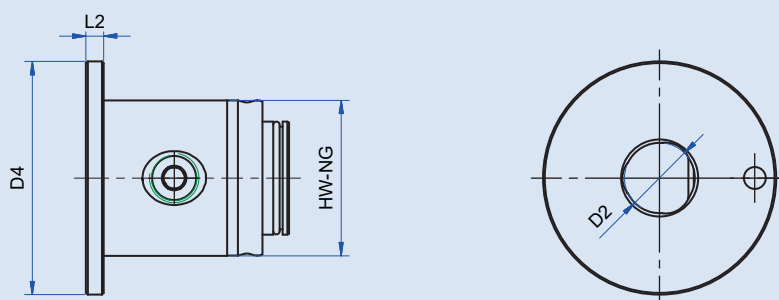

HW NG	D4	L2	Spannung DIN Tension DIN	D2	D2	D2	D2	D2	D2	D2	D2	D2	D2	D2	D2	Bestell-Nr. Order No. No. de commande
16	34	3	1835-E	6	-	-	-	-	-	-	-	-	-	-	-	127.160.-.113
16	34	3	1835-B	6	-	-	-	-	-	-	-	-	-	-	-	127.160.-.114
24	37	3	1835-E	6	8	10	-	-	-	-	-	-	-	-	-	127.240.-.113
24	37	3	1835-B	6	8	10	-	-	-	-	-	-	-	-	-	127.240.-.114
24	37	6	1835-B	-	-	-	12	-	-	-	-	-	-	-	-	127.240.12.114
34	56	5	1835-E	6	8	10	12	14	16	18	20	-	-	-	-	127.340.-.113
34	56	5	1835-B	6	8	10	12	14	16	18	20	-	-	-	-	127.340.-.114
44	66	5	1835-E	6	8	10	12	14	16	18	20	-	-	-	-	127.440.-.113
44	66	15	1835-E	-	-	-	-	-	-	-	-	25	-	-	-	127.440.25.113
44	66	6	1835-B	6	8	10	12	14	16	18	20	25	-	-	-	127.440.-.114
60	92	10	1835-B	-	-	-	-	-	-	-	-	-	-	32	-	127.600.32.114

IK = Kühlung durch die Aufnahmebohrung | IK = Cooling thru location hole | IK = Refroidissement par le trou du logement

Typ 127 HW-Wechseleinsätze

Type 127 HW-Interchangeable inserts | Type 127 Inserts interchangeable HW



- Hydrodehnaufnahme = 127.- - - .115
- Weitere Ausführungen nach Kundenwunsch auf Anfrage
- Hydraulic holder = 127.- - - .115
- Additional configurations according to customer requirements if requested
- Porte-outils mandrin hydraulique = 127.- - - .115
- D'autres exécutions possibles selon les souhaits du client sur demande

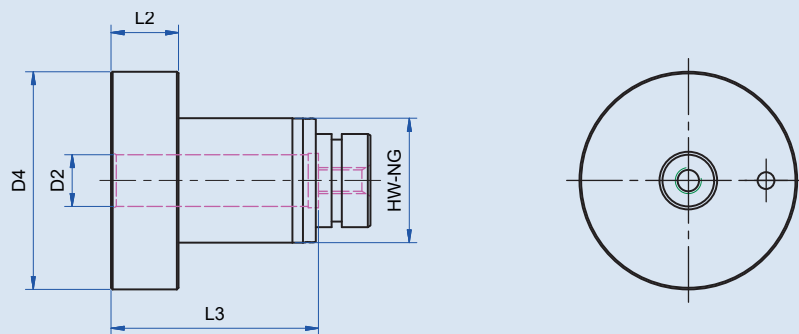

HW NG	D2	D4	L2	L3	Bestell-Nr. Order No. No. de commande
24	6	42	13	36	127.240.06.115
24	8	42	13	36	127.240.08.115
24	10	42	13	40	127.240.10.115
44	20	66	15	52	127.440.20.115
60	20	92	15	52	127.600.20.115

IK = Kühlung durch die Aufnahmebohrung | IK = Cooling thru location hole | IK = Refroidissement par le trou du logement

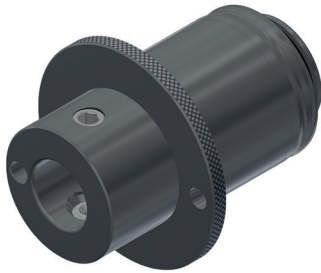

- ABS-NC-Aufnahme - Lizenz Komet - = 127.-.-.-.116
- Weitere Ausführungen nach Kundenwunsch auf Anfrage
- ABS-NC-Holder - Lizenz Komet - = 127.-.-.-.116
- Additional configurations according to customer requirements if requested
- Porte-outils ABS-NC - Licence Komet - = 127.-.-.-.116
- D'autres exécutions possibles selon les souhaits du client sur demande

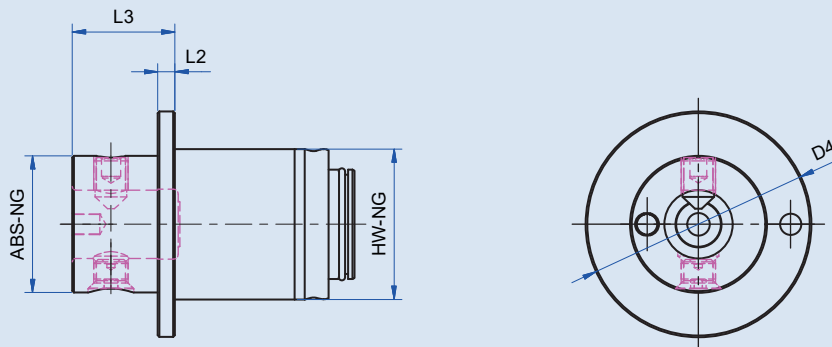

HW	NG	ABS	NG	D4	L2	L3	Bestell-Nr.
							Order No.
							No. de commande
44		40		66	5	30	127.440.40.116
44		50		66	5	30	127.440.50.116

IK = Kühlung durch die Aufnahmebohrung | IK = Cooling thru location hole | IK = Refroidissement par le trou du logement

Typ 127 HW-Wechseleinsätze

Type 127 HW-Interchangeable inserts | Type 127 Inserts interchangeables HW

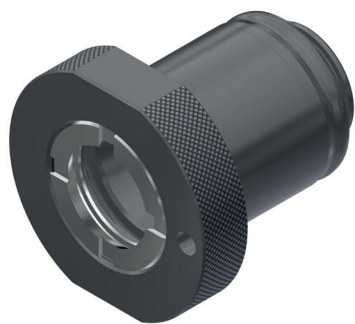

- Spannzangenaufnahme DIN 6499 = 127.- - - - .121
- Weitere Ausführungen nach Kundenwunsch auf Anfrage
- Collet chuck DIN 6499 = 127.- - - - .121
- Additional configurations according to customer requirements if requested
- Mandrin porte-pince DIN 6499 = 127.- - - - .121
- D'autres exécutions possibles selon les souhaits du client sur demande

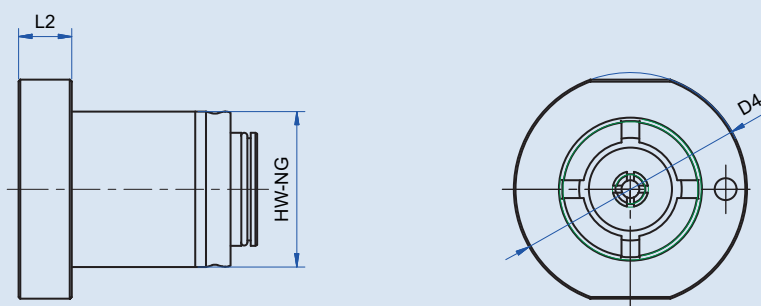

HW NG	Spannung DIN Tension DIN Tension DIN	D4	L2	Bestell-Nr. Order No. No. de commande
16	ER11	34	9	127.160.07.121
24	ER16	37	13	127.240.10.121
34	ER16	56	5	127.340.10.121
34	ER20	56	15	127.340.13.121
34	ER25	56	15	127.340.16.121
44	ER16	66	5	127.440.10.121
44	ER20	66	5	127.440.13.121
44	ER25	66	5	127.440.16.121
44	ER32	66	15	127.440.20.121
44	ER32	66	34	127.440.20.122 ¹⁾
44	ER40	66	40	127.440.26.121 ¹⁾
60	ER40	92	50	127.600.26.122 ¹⁾

IK = Kühlung durch die Spannzange | IC = Cooling thru collet chuck | IK = Refroidissement par pince de serrage

¹⁾ = Außenliegende Spannmutter | ¹⁾ IK = External clamping nut | ¹⁾ Écrou de serrage extérieur



- Fräseraufnahme = 127.- - - - .125
- Weitere Ausführungen nach Kundenwunsch auf Anfrage
- Milling cutter holder = 127.- - - - .125
- Additional configurations according to customer requirements if requested
- Porte-outils fraise = 127.- - - - .125
- D'autres exécutions possibles selon les souhaits du client sur demande

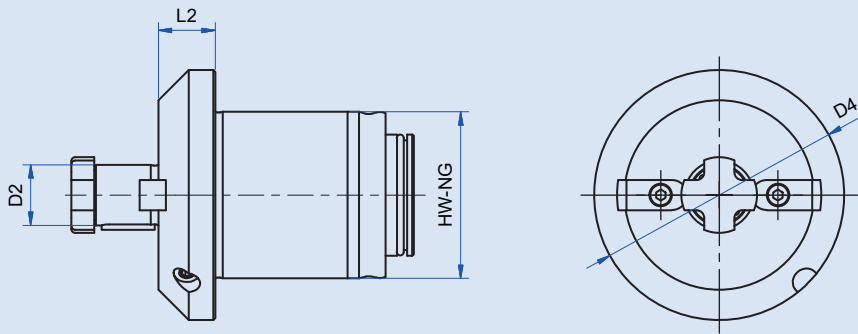

HW	NG	D2	D4	L2	Bestell-Nr. Order No. No. de commande
34		16	66	15	127.340.16.125
44		13	66	15	127.440.13.125
44		16	66	15	127.440.16.125
44		22	66	15	127.440.22.125

Typ 127 HW-Wechseleinsätze

Type 127 HW-Interchangeable inserts | Type 127 Inserts interchangeable HW



- Spannzangenfutter Softsynchro - System Emuge = 127.-.-.-.801
- Weitere Ausführungen nach Kundenwunsch auf Anfrage
- Collet chuck Softsynchro - System Emuge = 127.-.-.-.801
- Additional configurations according to customer requirements if requested
- Mandrin porte-fraises système Soft-Synchro Emuge = 127.-.-.-.801
- D'autres exécutions possibles selon les souhaits du client sur demande

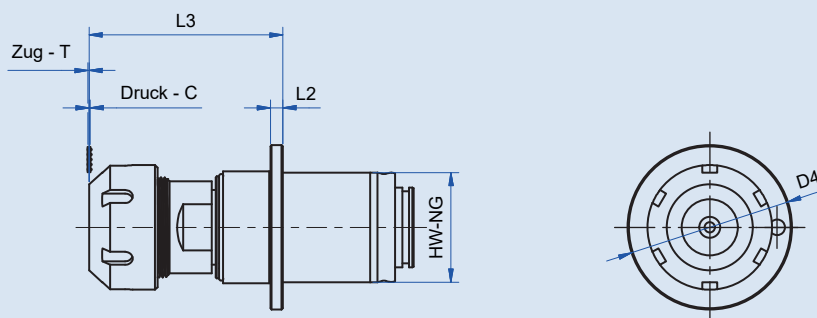

HW NG	Softsynchro NG	Gewinde NG Thread NG Fil NG	SZ NG		D4	L2	L3		C	T			Bestell-Nr. Order No. No. de commande
44	3	M4 - M20	ER32		66	5	78		0,5	0,5			127.440.20.801

IK = Kühlung durch die Aufnahmebohrung | IK = Cooling thru location hole | IK = Refroidissement par le trou du logement

Typ 180 HW-Werkzeugaufnahme axial

Type 180 HW-tool holder axial | Type 180 Porte-outils HW axial



- Mit IK durch die Aufnahmebohrung
- Weitere Ausführungen nach Kundenwunsch auf Anfrage
- With IK through the holder bore
- Additional configurations according to customer requirements if requested
- Avec refroidissement interne par trou de positionnement
- D'autres exécutions possibles selon les souhaits du client sur demande

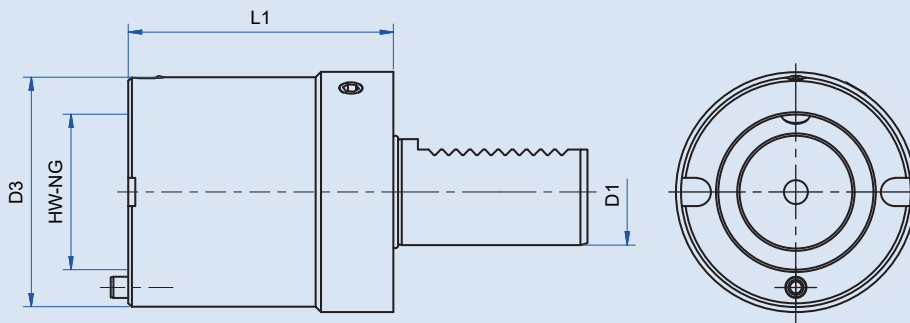

D1	HW NG	D3	L1	Bestell-Nr. Order No. No. de commande
30	44	65	75	180.030-A6157
40	44	65	75	180.040.44.075

Typ 180.0 HW-Werkzeugaufnahme axial 2-fach

Type 180.0 HW-tool holder axial 2x | Type 180.0 Porte-outils HW axial double

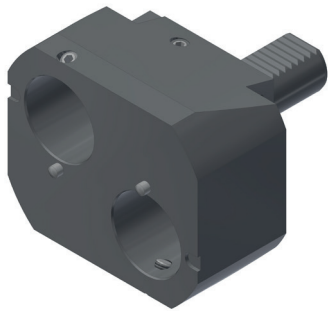

- Mit IK durch die Aufnahmebohrung
- Weitere Ausführungen nach Kundenwunsch auf Anfrage
- With IK through the holder bore
- Additional configurations according to customer requirements if requested
- Avec refroidissement interne par trou de positionnement
- D'autres exécutions possibles selon les souhaits du client sur demande

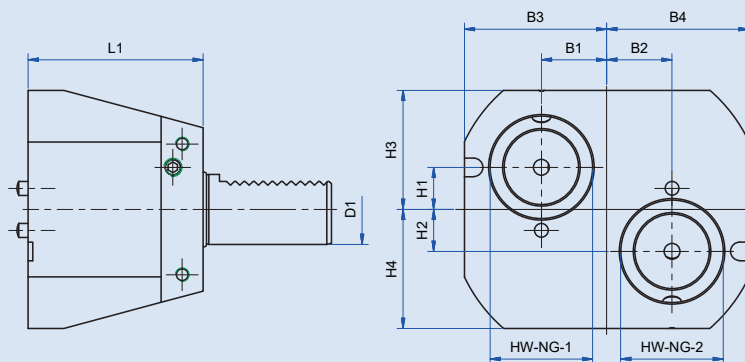

D1	HW NG 1 / 2	B1	B2	B3	B4	H1	H2	H3	H4	L1	Bestell-Nr. Order No. No. de commande
30	44 / 44	28	28	61	61	18	18	51	51	75	180.030-A6156

Typ 180.2 HW-Werkzeugaufnahme 90° - abgewinkelt

Type 180.2 HW-tool holder 90° - angled | Type 180.2 Porte-outils HW 90° - coudé

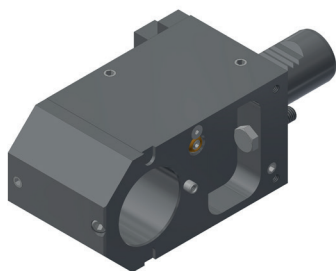

- Mit Doppelverzahnung
 - Mit IK durch die Aufnahmebohrung
 - Weitere Ausführungen nach Kundenwunsch auf Anfrage
- With double-toothed edge
 - With IK through the holder bore
 - Additional configurations according to customer requirements if requested
- Avec double denture
 - Avec refroidissement interne par trou de positionnement
 - D'autres exécutions possibles selon les souhaits du client sur demande

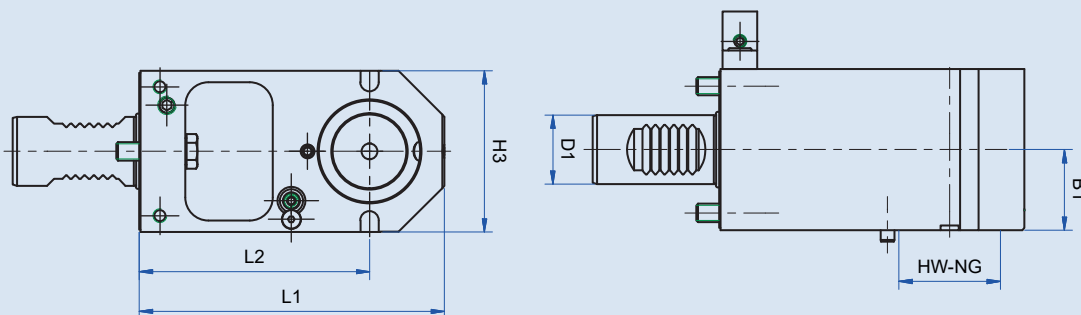

D1	HW NG							B1	H3	L1	L2					Bestell-Nr. Order No. No. de commande
25	34							30	60	102,5	175					180.225-A7143
30	44							35	70	133	100					180.230.44.1552
30	44							35	70	163	130					180.230-A6049
40	44							42,5	76	133	100					180.240.44.1002
40	44							42,5	76	153	120					180.240.44.1202

IK = Kühlung durch die Aufnahmebohrung + Kugelspritzdüse verschließbar

IK = Cooling thru location hole + ball nozzle closure | IK = Refroidissement par le trou du logement + buse à bille d'arrosage réglable verschließbar

Typ 180.2 HW-Werkzeugaufnahme 90° - abgewinkelt 2-fach

Type 180.2 HW-tool holder 90° - angle 2x | Type 180.2 Porte-outils HW 90° - coudé 2 fois

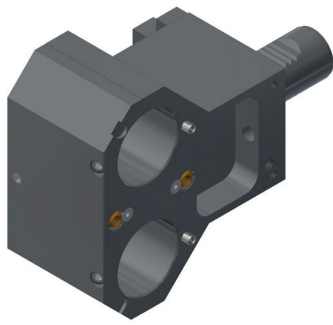

- Mit Doppelverzahnung
 - Mit IK durch die Aufnahmebohrung
 - Weitere Ausführungen nach Kundenwunsch auf Anfrage
- With double-toothed edge
 - With IK through the holder bore
 - Additional configurations according to customer requirements if requested
- Avec double denture
 - Avec refroidissement interne par trou taraudé
 - D'autres exécutions possibles selon les souhaits du client sur demande

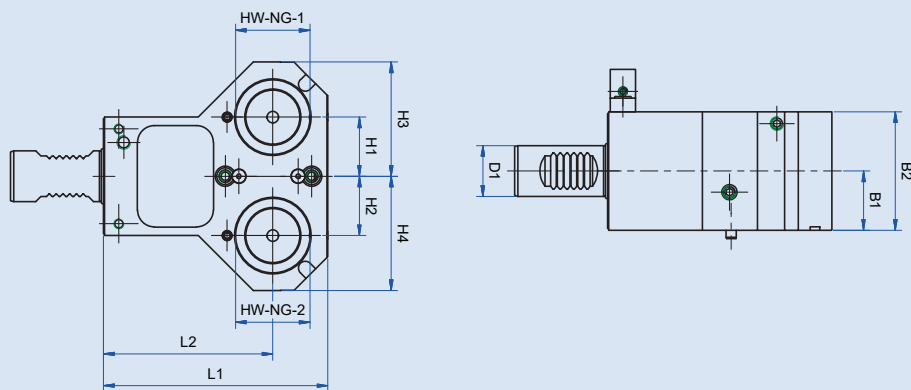

D1	HW NG 1 / 2	B1	B2	H1	H2	H3	H4	L1	L2	Bestell-Nr. Order No. No. de commande
30	34 / 34	35	70	35	35	62,5	62,5	117	90	180.230-A7447
30	44 / 44	35	70	35	35	67,5	67,5	133	100	180.230-A5564
30	44 / 44	35	70	35	35	68	68	163	130	180.230-A5948

IK = Kühlung durch die Aufnahmebohrung + Kugelspritzdüse verschleißbar

IK = Cooling thru location hole + ball nozzle closure | IK = Refroidissement par le trou du logement + buse à bille d'arrosage réglable vieillissable

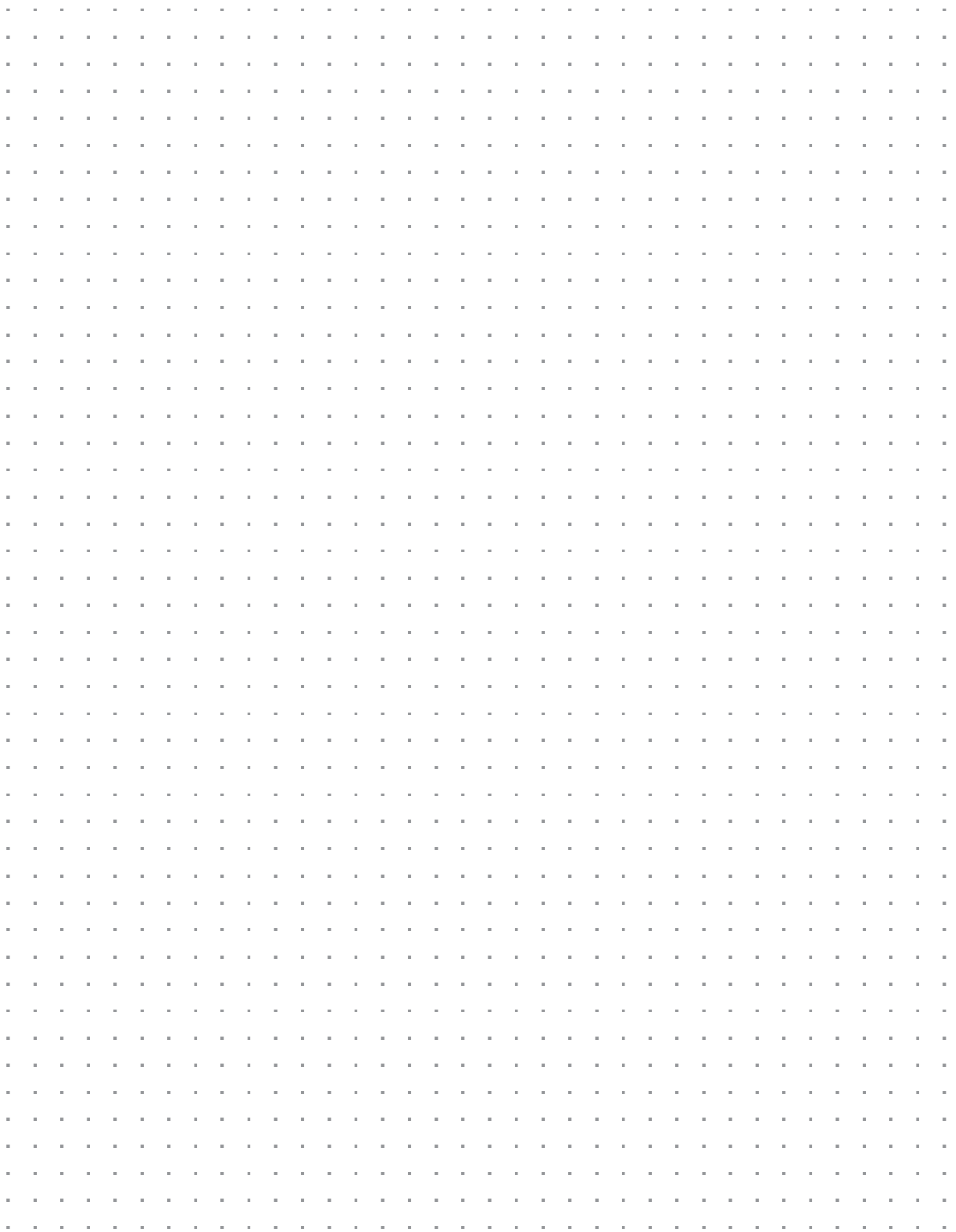

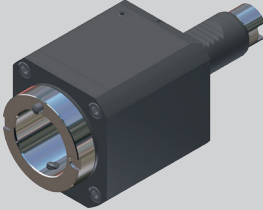
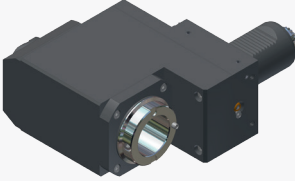
	<p>Typ 280.0 HW Axial Bohr- und Fräskopf</p> <ul style="list-style-type: none"> ▪ Bearbeiten mit höchster Stabilität ▪ Rüstzeit verkürzen durch voreingestellte Wechseleinsätze ▪ Standzeit verlängern durch kürzeste Bauweise, optimale Werkzeugspannung und spezieller Kühlmittelzufuhr ▪ Weitere Ausführungen nach Kundenwunsch auf Anfrage 	<p>Typ 280.0 HW Axial bore and milling head</p> <ul style="list-style-type: none"> ▪ Manufactured with highest stability ▪ Reduced set-up time by pre-set interchangeable inserts ▪ Extended service life due to short construction optimal tool tension and special coolant supply ▪ Additional configurations as per customer requirement upon request 	<p>Typ 280.0 HW Tête de forage et de fraisage axial</p> <ul style="list-style-type: none"> ▪ Usiner avec la meilleure stabilité ▪ Réduire le temps de préparation au moyen d'inserts interchangeables pré-réglés ▪ Prolonger la durabilité au moyen d'une construction courte, du serrage optimal des outils et d'une alimentation en liquide de refroidissement spéciale. ▪ D'autres exécutions possibles selon les souhaits du client sur demande
	<p>Typ 280.4 HW Winkel Bohr- und Fräskopf zurückgesetzt</p> <ul style="list-style-type: none"> ▪ Bearbeiten mit höchster Stabilität ▪ Rüstzeit verkürzen durch voreingestellte Wechseleinsätze ▪ Standzeit verlängern durch kürzeste Bauweise, optimale Werkzeugspannung und spezieller Kühlmittelzufuhr ▪ Weitere Ausführungen nach Kundenwunsch auf Anfrage 	<p>Typ 280.4 HW angle Drilling and milling head reset</p> <ul style="list-style-type: none"> ▪ Manufactured with highest stability ▪ Reduced set-up time by pre-set interchangeable inserts ▪ Extended service life due to short construction optimal tool tension and special coolant supply ▪ Additional configurations as per customer requirement upon request 	<p>Typ 280.4 Angle HW Tête de forage et fraisage décalé</p> <ul style="list-style-type: none"> ▪ Usiner avec la meilleure stabilité ▪ Réduire le temps de préparation au moyen d'inserts interchangeables pré-réglés ▪ Prolonger la durabilité au moyen d'une construction courte, du serrage optimal des outils et d'une alimentation en liquide de refroidissement spéciale. ▪ D'autres exécutions possibles selon les souhaits du client sur demande

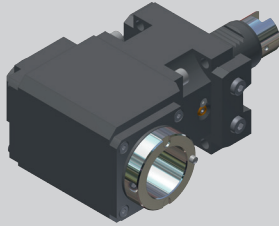

Typ 280.2 HW Winkel Bohr- und Fräskopf

- Kompaktbaureihe verschraubbar
- Bearbeiten mit höchster Stabilität
- Rüstzeit verkürzen durch voreingestellte Wechseleinsätze
- Standzeit verlängern durch kürzeste Bauweise, optimale Werkzeugspannung und spezieller Kühlmittelzufuhr
- Weitere Ausführungen nach Kundenwunsch auf Anfrage

Type 280.2-K HW Angle bore and milling head

- Compact series can be screwed
- Manufactured with highest stability
- Reduced set-up time by pre-set interchangeable inserts
- Extended service life due to short construction optimal tool tension and special coolant supply
- Additional configurations per customer requirement if requested

Type 280.2-K HW Tête de forage et de fraisage coudé

- Série compacte vissable
- Usiner avec la meilleure stabilité
- Réduire le temps de préparation au moyen d'inserts interchangeables pré-réglés
- Prolonger la durabilité au moyen d'une construction courte, du serrage optimal des outils et d'une alimentation en liquide de refroidissement spéciale.
- D'autres exécutions possibles selon les souhaits du client sur demande

DIN5480 Angetriebene Werkzeuge HW-Wechselsystem

DIN5480 Power driven tools HW-change system | DIN5480 Outils entraînés système interchangeable HW

Axial- Bohr- und Fräskopf | Axial drilling and milling head | Tête de perçage-fraisage axial

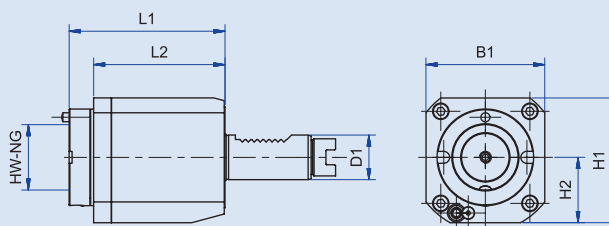
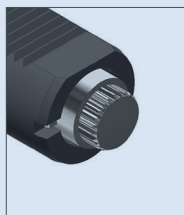
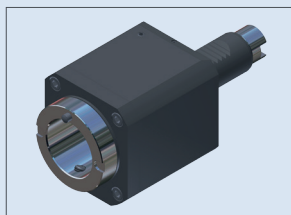

D1	Antriebs Typ Drive type Type d'entraînement	HW NG	B1	H1	H2	L1	L2	n max. min-1	T max. Nm	Übersetzung Gear ratio Ratio d'engrenage	Kühlmittel Coolant Liquide de refroidissement	Bestell-Nr. Order No. No. de commande
25	5480 - W14x0,8	34	70	70	35	85	70,5	6000	16	1 : 1	IK - 80bar	280.025.34.555
30	5480 - W16x0,8	44	80	84	44	105	90,5	6000	30	1 : 1	IK - 80bar	280.030.44.555
40	5480 - W20x0,8	44	80	84	44	105	90,5	6000	50	1 : 1	IK - 80bar	280.040.44.555
50	5480 - W24x1,25	44	96	102	54	105	91	6000	100	1 : 1	IK - 80bar	280.050.44.555
50	5480 - W24x1,25	60	110	110	55	115	98,5	6000	100	1 : 1	IK - 80bar	280.050.60.555

Desaxial- Bohr- und Fräskopf | Desaxial drilling and milling head | Tête de perçage-fraisage désaxial

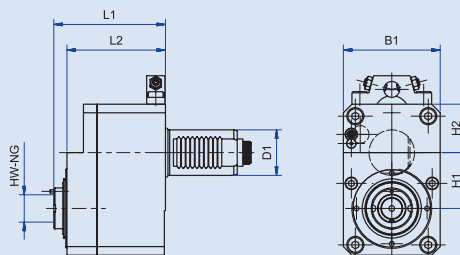
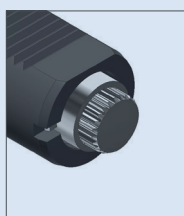
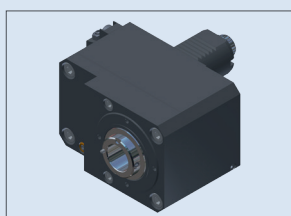

D1	Antriebs Typ Drive type Type d'entraînement	R / L	HW	B1	H1	H2	L1	L2	n max. min-1	T max. Nm	Übersetzung Gear ratio Ratio d'engrenage	Kühlmittel Coolant Liquide de refroidissement	Bestell-Nr. Order No. No. de commande
30	5480 - W16x0,8	R	24	85	49	48	102	90,5	10000	17	1 : 3	IK-80bar	280.530-A7570
40	5480 - W20x0,8	R	24	85	49	42,5	98	86,5	10000	16	1 : 3	IK-80bar	280.540-A6790
40	5480 - W20x0,8	R	24	85	49	42,5	98	86,5	9600	28	1 : 1,6	IK-80bar	280.540-A7286

DIN5480 Angetriebene Werkzeuge HW-Wechselsystem

DIN5480 Power driven tools HW-change system | DIN5480 Outils entraînés système interchangeable HW

Radial- Bohr- und Fräskopf | Radial drilling and milling head | Tête de perçage-fraisage radial

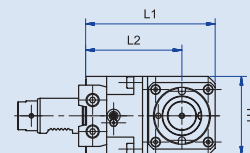
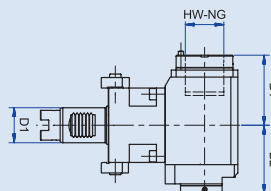
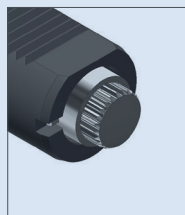
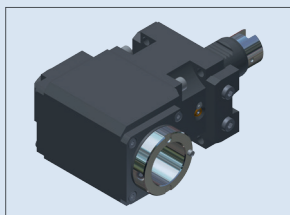

D1	Antriebs Typ Drive type Type d'entraînement	R / L	HW NG	B1	B2	H1	L1	L2	n max. min-1	T max. Nm	Übersetzung Gear ratio Ratio d'engrenage	Kühlmittel Coolant Liquide de refroidissement	Bestell-Nr. Order No. No. de commande
30	5480 - W16x0,8	R / L	34	85	77	90	133	100	6000	54	1 : 1	IK	280.230-A5852
30	5480 - W16x0,8	R / L	44	80	78	90	138	100	6000	54	1 : 1	IK	280.230-A6237
40	5480 - W20x0,8	R / L	34	80	77	90	153	120	6000	54	1 : 1	IK	280.240.34.5762
40	5480 - W20x0,8	R / L	44	80	78	90	158	120	6000	65	1,5 : 1	IK	280.240.44.5782
40	5480 - W20x0,8	R / L	44	92	75	88	164	120	6000	100	1 : 1	EK	280.240.44.5712
40	5480 - W20x0,8	R / L	44	92	86	88	164	120	6000	100	1 : 1	IK	280.240.44.5762
50	5480 - W24x1,25	R / L	44	92	86	88	164	120	6000	100	2 : 1	IK	280.250.44.5782
50	5480 - W24x1,25	R / L	60	105	75	110	173	120	6000	100	1 : 1	EK	280.250.60.5712
50	5480 - W24x1,25	R / L	60	105	75	110	173	120	6000	100	2 : 1	EK	280.250.60.5732
50	5480 - W24x1,25	R / L	60	105	86	110	173	120	6000	100	1 : 1	IK	280.250.60.5762
50	5480 - W24x1,25	R / L	60	105	86	110	173	120	6000	100	2 : 1	IK	280.250.60.5782

DIN5482 Angetriebene Werkzeuge HW-Wechselsystem

DIN5482 Power driven tools HW-change system | DIN5482 Outils entraînés système interchangeable HW

Axial- Bohr- und Fräskopf | Axial drilling and milling head | Tête de perçage-fraisage axial

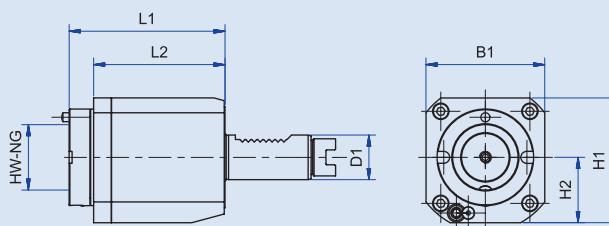
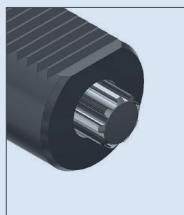
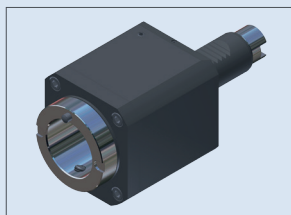

D1	Antriebs Typ Drive type Type d'entraînement	HW NG	B1	H1	H2	L1	L2	n max. min-1	T max. Nm	Übersetzung Gear ratio Ratio d'engrenage	Kühlmittel Coolant Liquide de refroidissement	Bestell-Nr. Order No. No. de commande
30	5482 - B15x12	34	80	84	44	105	88,5	6000	30	1 : 1	IK	280.030.34.155
40	5482 - B17x14	44	80	84	44	105	88,5	6000	50	1 : 1	EK	280.040.44.150
40	5482 - B17x14	44	80	84	44	80	62,5	6000	50	1 : 1	IK	280.040.44.156
50	5482 - B20x17	44	80	84	44	105	88,5	6000	100	1 : 1	IK	280.050.44.155
50	5482 - B20x17	34	80	84	44	95	79	6000	50	1 : 1	IK	280.050.34.156
60	5482 - B25x22	44	88	102	54	110	95,5	6000	120	1 : 1	EK	280.060.44.151
60	5482 - B25x22	44	88	102	54	110	95,5	6000	120	1 : 1	IK	280.060.44.156

Radial- Bohr- und Fräskopf zurückgesetzt | Radial drilling and milling head reset | Tête de perçage-fraisage radial remis à zéro

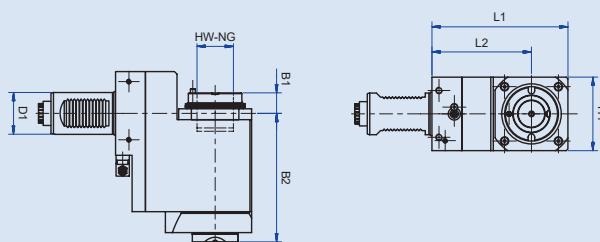
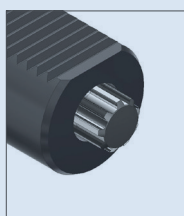
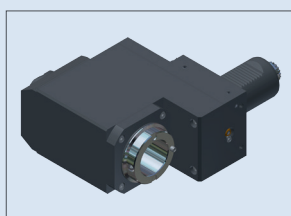

D1	Antriebs Typ Drive type Type d'entraînement	R / L	HW NG	B1	B2	H1	L1	L2	n max. min-1	T max. Nm	Übersetzung Gear ratio Ratio d'engrenage	Kühlmittel Coolant Liquide de refroidissement	Bestell-Nr. Order No. No. de commande
30	5482 - B15x12	R	34	25	90	80	140	100	6000	46	1 : 1	IK	280.430-A7292
40	5482 - B17x14	R	44	25	90	80	140	100	6000	46	1 : 1	IK	280.440.44.155

Index Angetriebene Werkzeuge HW-Wechselsystem

Index Power driven tools HW-change system | Index Outils entraînés système interchangeable HW

Axial- Bohr- und Fräskopf | Axial drilling and milling head | Tête de perçage-fraisage axial

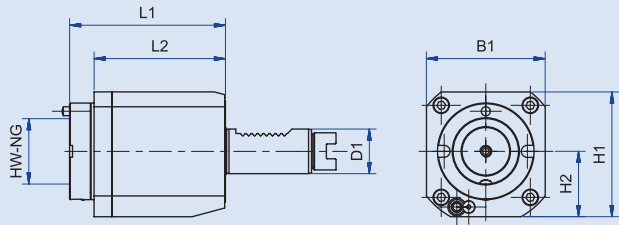
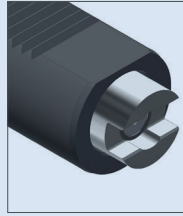
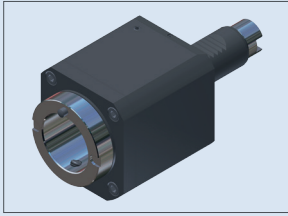

D1	Antriebs Typ Drive type Type d'entraînement	HW NG	B1	H1	H2	L1	L2	n max. min-1	T max. Nm	Übersetzung Gear ratio Ratio d'engrenage	Kühlmittel Coolant Liquide de refroidissement	Bestell-Nr. Order No. No. de commande
25	Index - G 200	34	70	70	35	85	68,5	6000	16	1 : 1	EK	280.025.34.510
25	Index - G 200	34	70	70	35	85	70,5	6000	16	1 : 1	IK - 80bar	280.025.34.515
30	Index - G 300	34	80	84	44	105	88,5	6000	30	1 : 1	EK	280.030.34.510
30	Index - G 300	34	40	84	44	80	63,5	6000	30	1 : 1	EK	280.030.34.511
30	Index - G 300	34	80	84	44	105	90,5	6000	30	1 : 1	IK - 80bar	280.030.34.515
30	Index - G 300	34	80	84	44	80	63,5	6000	30	1 : 1	IK - 80bar	280.030.34.516
30	Index - G 300	44	80	84	44	105	90,5	6000	30	1 : 1	IK - 80bar	280.030.44.515
40	Index - G 400	34	80	84	44	80	63,5	4500	30	1 : 1	EK	280.040.34.511
40	Index - G 400	34	80	84	44	80	63,5	4500	30	1 : 1	IK - 80bar	280.040.34.516
40	Index - G 400	44	80	84	44	80	63,5	4500	40	1 : 1	EK	280.040.44.511
40	Index - G 400	44	80	84	44	80	63,5	3000	40	1 : 1	IK - 80bar	280.040.44.516

Desaxial- Bohr- und Fräskopf | Desaxial drilling and milling head | Tête de perçage-fraisage désaxial

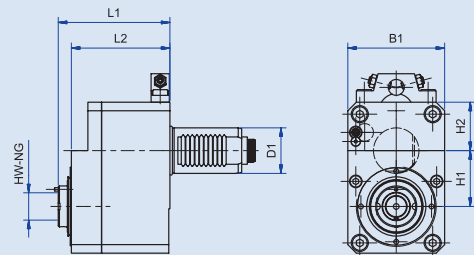
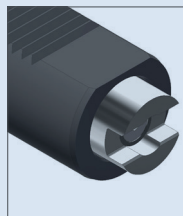
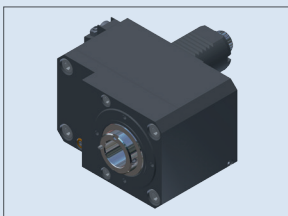

D1	Antriebs Typ Drive type Type d'entraînement	R / L	HW	B1	H1	H2	L1	L2	n max. min-1	T max. Nm	Übersetzung Gear ratio Ratio d'engrenage	Kühlmittel Coolant Liquide de refroidissement	Bestell-Nr. Order No. No. de commande
30	Index - G 300	R / L	24	70	30	52,5	90	72	6000	11	1 : 2	EK	280.530.24.5102
30	Index - G 300	R / L	24	70	30	52,5	90	72	6000	11	1 : 2	IK	280.530.24.5152

Index Angetriebene Werkzeuge HW-Wechselsystem

Index Power driven tools HW-change system | Index Outils entraînés système interchangeable HW

Radial- Bohr- und Fräskopf | Radial drilling and milling head | Tête de perçage-fraisage radial

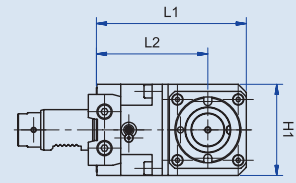
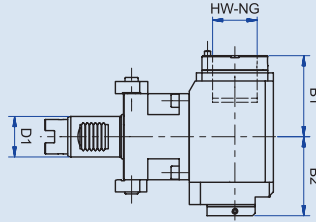
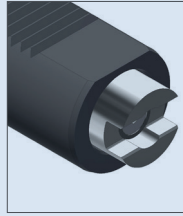
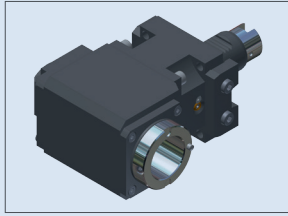

D1	Antriebs Typ Drive type Type d'entraînement	R / L	HW NG	B1	B2	H1	L1	L2	n max. min-1	T max. Nm	Übersetzung Gear ratio Ratio d'engrenage	Kühlmittel Coolant Liquide de refroidissement	Bestell-Nr. Order No. No. de commande
25	Index - G 200	R / L	24	57	48,5	64	98	70	6000	22	1 : 1	IK	280.225.24.5162
30	Index - G 300	R / L	34	75	64	70	123	90	6000	30	1 : 1	IK	280.230.34.5162

Moriseiki NL-Serie Angetriebene Werkzeuge HW-Wechselsystem

Moriseiki NL-Serie Power driven tools HW-change system | Moriseiki NL-Serie Outils entraînés système interchangeable HW

Axial- Bohr- und Fräskopf | Axial drilling and milling head | Tête de perçage-fraisage axial

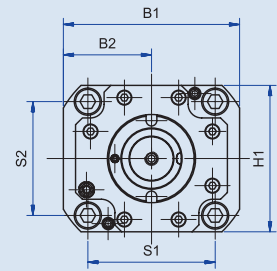
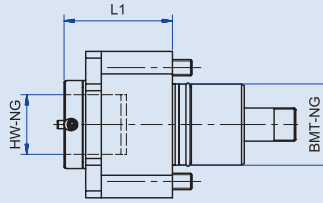
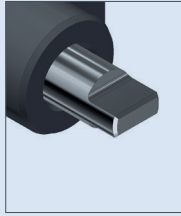
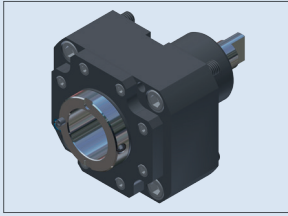

BMT NG	Antriebs Typ Drive type Type d'entraînement	HW NG	B1	B2	H1	L1	S1	S2	n max. min-1	T max. Nm	Übersetzung Gear ratio Ratio d'engrenage	Kühlmittel Coolant Liquide de refroidissement	Bestell-Nr. Order No. No. de commande
40	2 - flach	34	110	55	80	98	70	62	6000	60	1 : 1	EK	280.040.34.801
40	2 - flach	34	110	55	80	72	70	62	6000	60	1 : 1	IK	280.040.34.806
40	2 - flach	44	110	55	80	72	70	62	6000	60	1 : 1	EK	280.040.44.801
40	2 - flach	44	110	55	80	72	70	62	6000	60	1 : 1	IK	280.040.44.806
60	2 - flach	44	130	65	108	80	94	84	6000	100	1 : 1	EK	280.060.44.801
60	2 - flach	44	130	65	108	80	94	84	6000	100	1 : 1	IK	280.060.44.806

Radial- Bohr- und Fräskopf | Radial drilling and milling head | Tête de perçage-fraisage radial

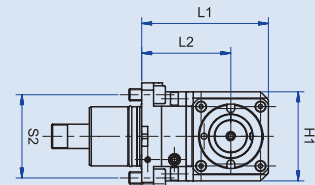
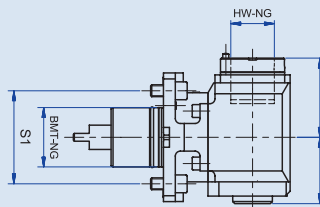
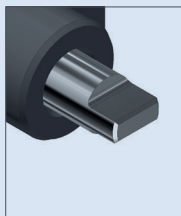
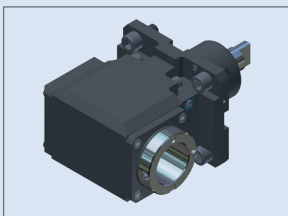

BMT NG	Antriebs Typ Drive type Type d'entraînement	HW NG	B1	B2	H1	L1	L2	S1	S2	n max. min-1	T max. Nm	Übersetzung Gear ratio Ratio d'engrenage	Kühlmittel Coolant Liquide de refroidissement	Bestell-Nr. Order No. No. de commande
40	2 - flach	44	80	67	90	123	85	70	62	6000	60	1 : 1	EK	280.240.44.801
40	2 - flach	44	80	78	90	123	85	70	62	6000	60	1 : 1	IK-80bar	280.240.44.806
40	2 - flach	44	80	67	90	123	85	70	62	6000	60	1,5 : 1	EK	280.240.44.803
40	2 - flach	44	80	78	90	123	85	70	62	6000	60	1,5 : 1	IK-80bar	280.240.44.808
60	2 - flach	44	80	67	90	128	90	94	84	6000	100	1 : 1	EK	280.260.44.801
60	2 - flach	44	80	78	90	128	90	94	84	6000	100	1 : 1	IK-80bar	280.260.44.806
60	2 - flach	44	80	67	90	128	90	94	84	6000	100	1,5 : 1	EK	280.260.44.803
60	2 - flach	44	80	78	90	128	90	94	84	6000	100	1,5 : 1	IK-80bar	280.260.44.808

DIN1809 Angetriebene Werkzeuge HW-Wechselsystem

DIN1809 Power driven tools HW-change system | DIN1809 Outils entraînés système interchangeable HW

Axial- Bohr- und Fräskopf | Axial drilling and milling head | Tête de perçage-fraisage axial

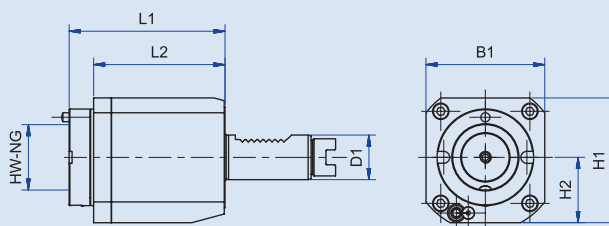
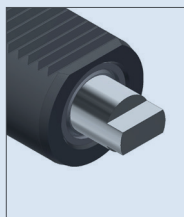
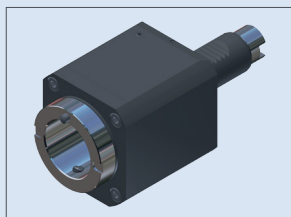

D1	Antriebs Typ Drive type Type d'entraînement	HW NG	B1	H1	H2	L1	L2	n max. min-1	T max. Nm	Übersetzung Gear ratio Ratio d'engrenage	Kühlmittel Coolant Liquide de refroidissement	Bestell-Nr. Order No. No. de commande
40	DIN 1809	44	80	84	44	105	88,5	6000	50	1 : 1	EK	280.040.44.450
40	DIN 1809	44	80	84	44	150	88,5	6000	50	1 : 1	IK	280.040.44.455

Radial- Bohr- und Fräskopf | Radial drilling and milling head | Tête de perçage-fraisage radial

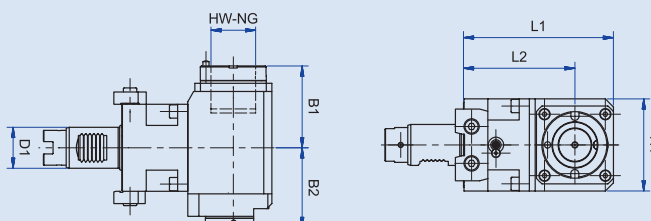
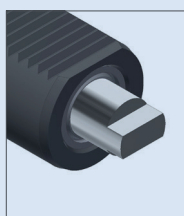
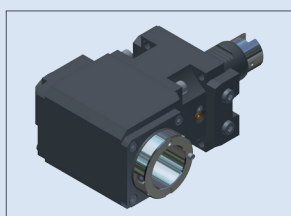

D1	Antriebs Typ Drive type Type d'entraînement	R / L	HW NG	B1	B2	H1	L1	L2	n max. min-1	T max. Nm	Übersetzung Gear ratio Ratio d'engrenage	Kühlmittel Coolant Liquide de refroidissement	Bestell-Nr. Order No. No. de commande
40	DIN 1809	R / L	44	80	69	90	128	90	6000	50	1 : 1	EK	280.240.44.4512
40	DIN 1809	R / L	44	80	78	90	128	90	6000	50	1 : 1	IK	280.240.44.4562

Haas Angetriebene Werkzeuge HW-Wechselsystem

Haas Power driven tools HW-change system | Haas Outils entraînés système interchangeable HW

Axial- Bohr- und Fräskopf | Axial drilling and milling head | Tête de perçage-fraisage axial

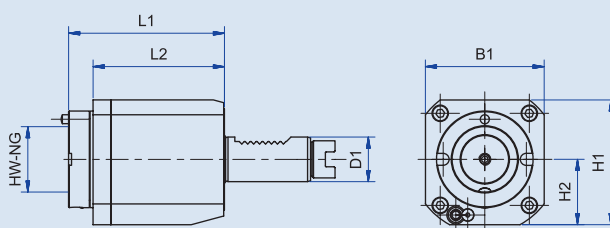
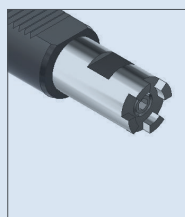
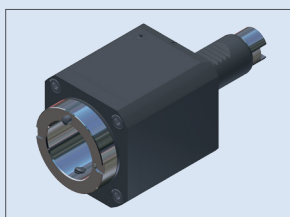

D1	Antriebs Typ Drive type Type d'entraînement	HW NG	B1	H1	H2	L1	L2	n max. min-1	T max. Nm	Übersetzung Gear ratio Ratio d'engrenage	Kühlmittel Coolant Liquide de refroidissement	Bestell-Nr. Order No. No. de commande
40	Haas	44	80	84	44	105	87	6000	50	1 : 1	EK	280.040.44.190
40	Haas	44	80	84	44	105	87	6000	50	1 : 1	IK	280.040.44.195
40	Haas	44	80	84	44	80	62,5	5000	50	1 : 1	EK	280.040.44.191
40	Haas	44	80	84	44	80	62,5	5000	50	1 : 1	IK	280.040.44.196

Radial- Bohr- und Fräskopf | Radial drilling and milling head | Tête de perçage-fraisage radial

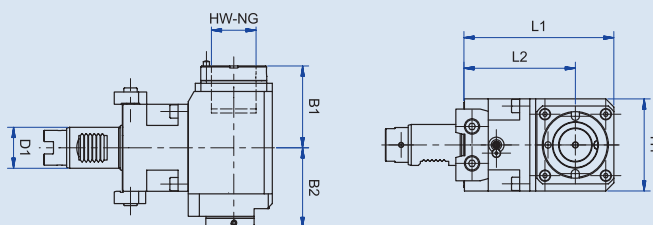
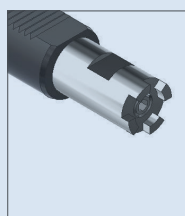
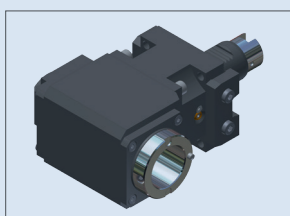

D1	Antriebs Typ Drive type Type d'entraînement	R / L	HW NG	B1	B2	H1	L1	L2	n max. min-1	T max. Nm	Übersetzung Gear ratio Ratio d'engrenage	Kühlmittel Coolant Liquide de refroidissement	Bestell-Nr. Order No. No. de commande
40	Haas	R	44	80	78	80	113	75	6000	50	1 : 1	EK	280.240.44.191
40	Haas	R	44	80	78	80	113	75	6000	50	1 : 1	IK	280.240.44.196
40	Haas	L	44	80	78	80	113	75	6000	50	1 : 1	EK	280.740.44.191
40	Haas	L	44	80	78	80	113	75	6000	50	1 : 1	IK	280.740.44.196

Okuma Angetriebene Werkzeuge HW-Wechselsystem

Okuma Power driven tools HW-change system | Okuma Outils entraînés système interchangeable HW

Axial- Bohr- und Fräskopf | Axial drilling and milling head | Tête de perçage-fraisage axial

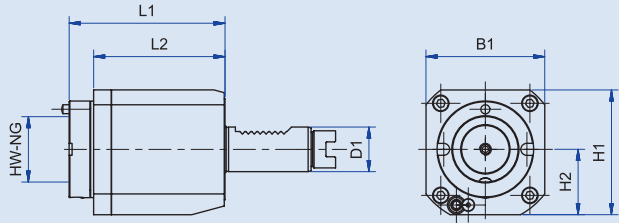
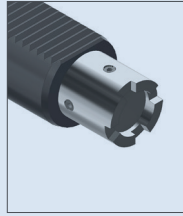
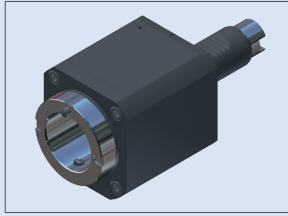

D1	Antriebs Typ Drive type Type d'entraînement	HW NG	B1	H1	H2	L1	L2	n max. min-1	T max. Nm	Übersetzung Gear ratio Ratio d'engrenage	Kühlmittel Coolant Liquide de refroidissement	Bestell-Nr. Order No. No. de commande
40	Okuma	44	80	84	44	80	62,5	6000	50	1 : 1	EK	280.040.44.250
40	Okuma	44	80	84	44	80	62,5	6000	50	1 : 1	IK	280.040.44.255

Doosan Angetriebene Werkzeuge HW-Wechselsystem

Doosan Power driven tools HW-change system | Doosan Outils entraînés système interchangeable HW

Axial- Bohr- und Fräskopf | Axial drilling and milling head | Tête de perçage-fraisage axial

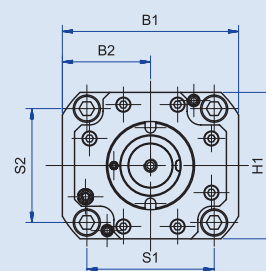
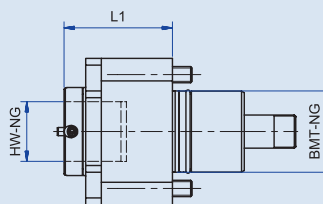
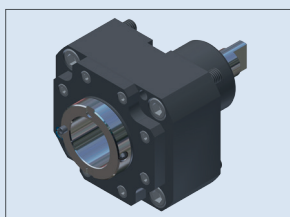

BMT NG	Antriebs Typ Drive type Type d'entraînement	HW NG	B1	B2	H1	L1	S1	S2	n max. min-1	T max. Nm	Übersetzung Gear ratio Ratio d'engrenage	Kühlmittel Coolant Liquide de refroidissement	Bestell-Nr. Order No. No. de commande
55	2 - flach	44	94	50	85	70	64	64	6000	60	1 : 1	EK	280.055.44.851
55	2 - flach	44	94	50	85	70	64	64	6000	60	1 : 1	IK	280.055.44.856
65	2 - flach	44	100	50	94	70	70	73	6000	60	1 : 1	IK	280.065.44.851
65	2 - flach	44	100	50	94	70	70	73	6000	60	1 : 1	EK	280.065.44.856
75	2 - flach	44	115	57,5	119	70	90	90	6000	60	1 : 1	IK	280.075.44.851
75	2 - flach	44	115	57,5	119	70	90	90	6000	100	1 : 1	EK	280.075.44.856

Radial- Bohr- und Fräskopf | Radial drilling and milling head | Tête de perçage-fraisage radial

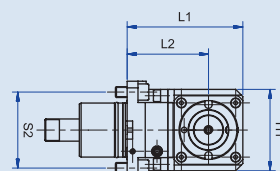
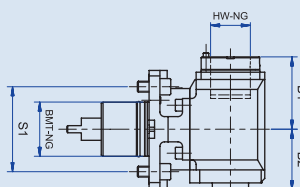
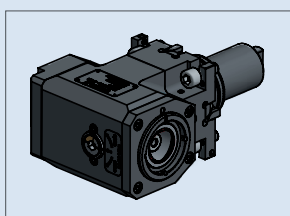

BMT NG	Antriebs Typ Drive type Type d'entraînement	HW NG	B1	B2	H1	L1	L2	S1	S2	n max. min-1	T max. Nm	Übersetzung Gear ratio Ratio d'engrenage	Kühlmittel Coolant Liquide de refroidissement	Bestell-Nr. Order No. No. de commande
55	2 - flach	44	80	67	90	123	85	64	64	6000	54	1 : 1	EK	280.255.44.851
55	2 - flach	44	80	67	90	123	85	64	64	6000	65	1,5 : 1	EK	280.255.44.853
55	2 - flach	44	80	78	90	123	85	64	64	6000	54	1 : 1	IK	280.255.44.856
55	2 - flach	44	80	78	90	123	85	64	64	6000	65	1,5 : 1	IK	280.255.44.858
65	2 - flach	44	80	67	90	123	85	70	73	6000	65	1 : 1	EK	280.265.44.851
65	2 - flach	44	80	67	90	123	85	70	73	6000	80	1,5 : 1	EK	280.265.44.853
65	2 - flach	44	80	78	90	123	85	70	73	6000	65	1 : 1	IK	280.265.44.856
65	2 - flach	44	80	78	90	123	85	70	73	6000	80	1,5 : 1	IK	280.265.44.858
75	2 - flach	44	80	67	105	123	85	90	90	6000	100	1 : 1	EK	280.275.44.851
75	2 - flach	44	80	67	105	123	85	90	90	6000	100	1 : 1	IK	280.275.44.856

EMAG BMT Angetriebene Werkzeuge HW-Wechselsystem

EMAG BMT Power driven tools HW-change system | EMAG BMT Outils entraînés système interchangeable HW

Axial- Bohr- und Fräskopf | Axial drilling and milling head | Tête de perçage-fraisage axial

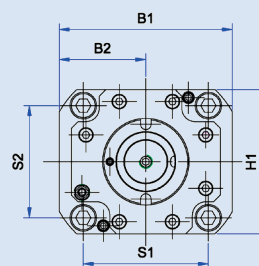
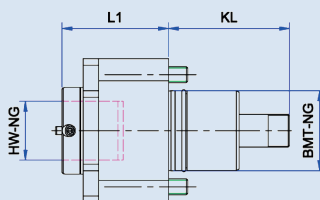
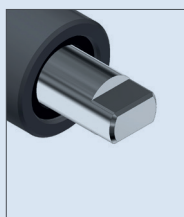
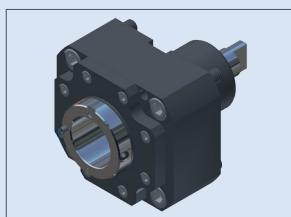

BMT NG	Antriebs Typ Drive type Type d'entraînement	HW NG	B1	B2	H1	L1	S1	S2	KL	n max. min-1	T max. Nm	Übersetzung Gear ratio Ratio d'engrenage	Kühlmittel Coolant Liquide de refroidissement	Bestell-Nr. Order No. No. de commande
55	EMAG	44	95	47,5	86	75	64	64	100	6000	80	1 : 1	EK	280.055.44.881
55	EMAG	44	95	47,5	86	75	64	64	100	6000	80	1 : 1	IK	280.055.44.886
55	EMAG	44	95	47,5	86	75	64	64	83	6000	80	1 : 1	EK	280.055.44.891
55	EMAG	44	95	47,5	86	75	64	64	83	6000	80	1 : 1	IK	280.055.44.896
65	EMAG	44	98	49	98	75	73	70	140	6000	100	1 : 1	EK	280.065.44.881
65	EMAG	44	98	49	98	75	73	70	140	6000	100	1 : 1	IK	280.065.44.886
65	EMAG	44	98	49	98	75	73	70	110	6000	100	1 : 1	EK	280.065.44.891
65	EMAG	44	98	49	98	75	73	70	110	6000	100	1 : 1	IK	280.065.44.896
75	EMAG	44	115	57,5	115	75	90	90	115	6000	100	1 : 1	EK	280.075.44.891
75	EMAG	44	115	57,5	115	75	90	90	115	6000	100	1 : 1	IK	280.075.44.896

Radial- Bohr- und Fräskopf | Radial drilling and milling head | Tête de perçage-fraisage radial

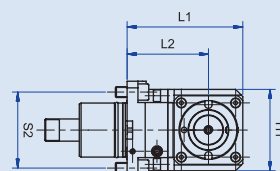
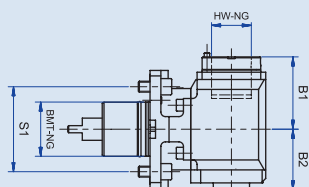
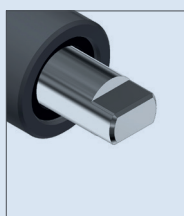
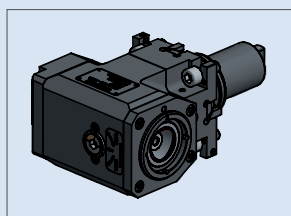

BMT NG	Antriebs Typ Drive type Type d'entraînement	HW NG	B1	B2	H1	L1	L2	S1	S2	n max. min-1	T max. Nm	Übersetzung Gear ratio Ratio d'engrenage	Kühlmittel Coolant Liquide de refroidissement	Bestell-Nr. Order No. No. de commande	KL
55	EMAG	44	80	67	90	125	85	64	64	6000	45	1 : 1	EK	280.255.44.881	100
55	EMAG	44	80	78	90	125	85	64	64	6000	45	1 : 1	IK	280.255.44.886	100
55	EMAG	44	80	67	90	125	85	64	64	6000	45	1 : 1	EK	280.255.44.891	83
55	EMAG	44	80	78	90	125	85	64	64	6000	45	1 : 1	IK	280.255.44.896	83
55	EMAG	44	80	67	90	125	85	64	64	6000	54	1,5 : 1	EK	280.255.44.893	100
55	EMAG	44	80	78	90	125	85	64	64	6000	54	1,5 : 1	IK	280.255.44.898	100
65	EMAG	44	80	67	90	170	130	70	73	6000	80	1 : 1	EK	280.265.44.881	140
65	EMAG	44	80	78	90	170	130	70	73	6000	80	1 : 1	IK	280.265.44.886	140
65	EMAG	44	80	67	90	125	85	70	73	6000	80	1 : 1	EK	280.265.44.891	140
65	EMAG	44	80	78	90	125	85	70	73	6000	80	1 : 1	IK	280.265.44.896	140
65	EMAG	44	80	67	90	170	130	70	73	6000	80	1,5 : 1	EK	280.265.44.893	140
65	EMAG	44	80	78	90	170	130	70	73	6000	80	1,5 : 1	IK	280.265.44.898	140
75	EMAG	44	80	67	105	125	85	90	90	6000	100	1 : 1	EK	280.275.44.891	115
75	EMAG	44	80	78	105	125	85	90	90	6000	100	1 : 1	IK	280.275.44.896	115

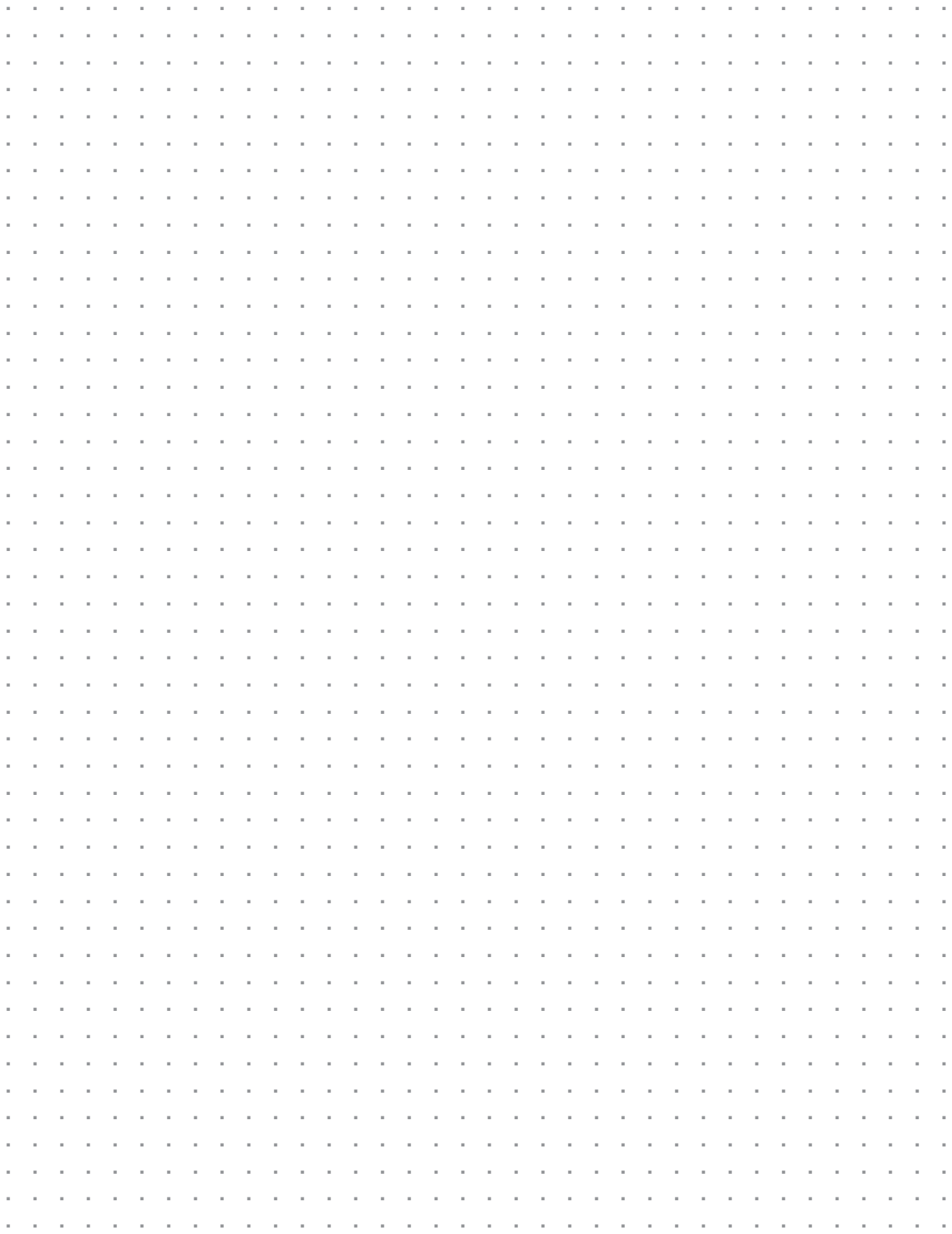

Typ 127 HW - Lagersystem

Type HW - storage system | Type 127 HW - Système de paliers



- Grundaufnahme - 180.00.00.012 für 12 Wechseleinsätze
- Bundbuchsen aus Kunststoff
HW 16 - 180.000.16.000
HW 24 - 180.000.24.000
HW 34 - 180.000.34.000
HW 44 - 180.000.44.000
- Weitere Ausführungen nach Kundenwunsch auf Anfrage
- Basic holder - 180.00.00.012 for 12 interchangeable inserts
- Flange sleeve made of plastic
HW 16 - 180.000.16.000
HW 24 - 180.000.24.000
HW 34 - 180.000.34.000
HW 44 - 180.000.44.000
- Additional configurations according to customer requirements if requested
- Porte-outils de base - 180.00.00.012 pour 12 inserts interchangeables
- Douille à collerette en plastique
HW 16 - 180.000.16.000
HW 24 - 180.000.24.000
HW 34 - 180.000.34.000
HW 44 - 180.000.44.000
- D'autres exécutions possibles selon les souhaits du client sur demande

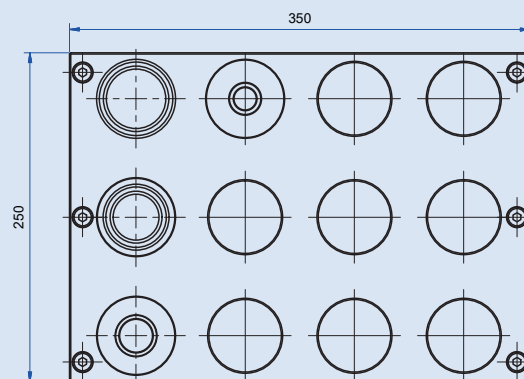
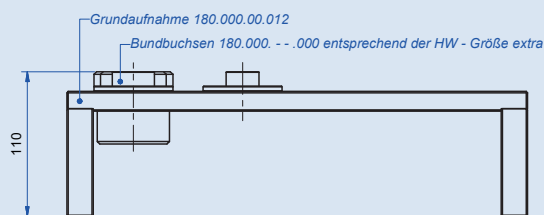



- Weitere Ausführungen nach Kundenwunsch auf Anfrage
- Additional configurations according to customer requirements if requested
- D'autres exécutions possibles selon les souhaits du client sur demande

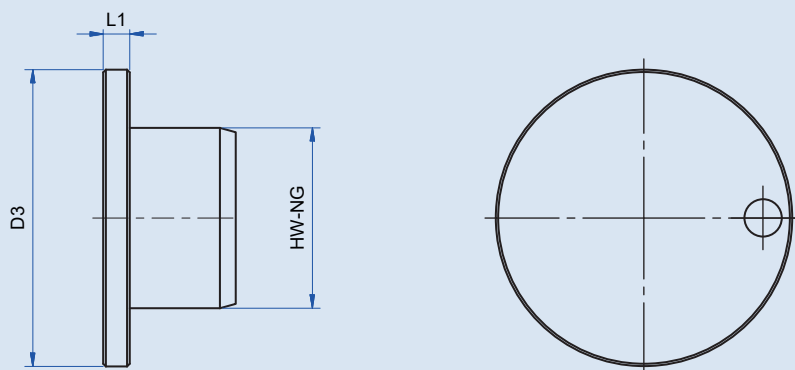

HW NG	D3	L1	Bestell-Nr. Order No. No. de commande
34	56	5	127.340.00.149
44	66	5	127.440.00.149

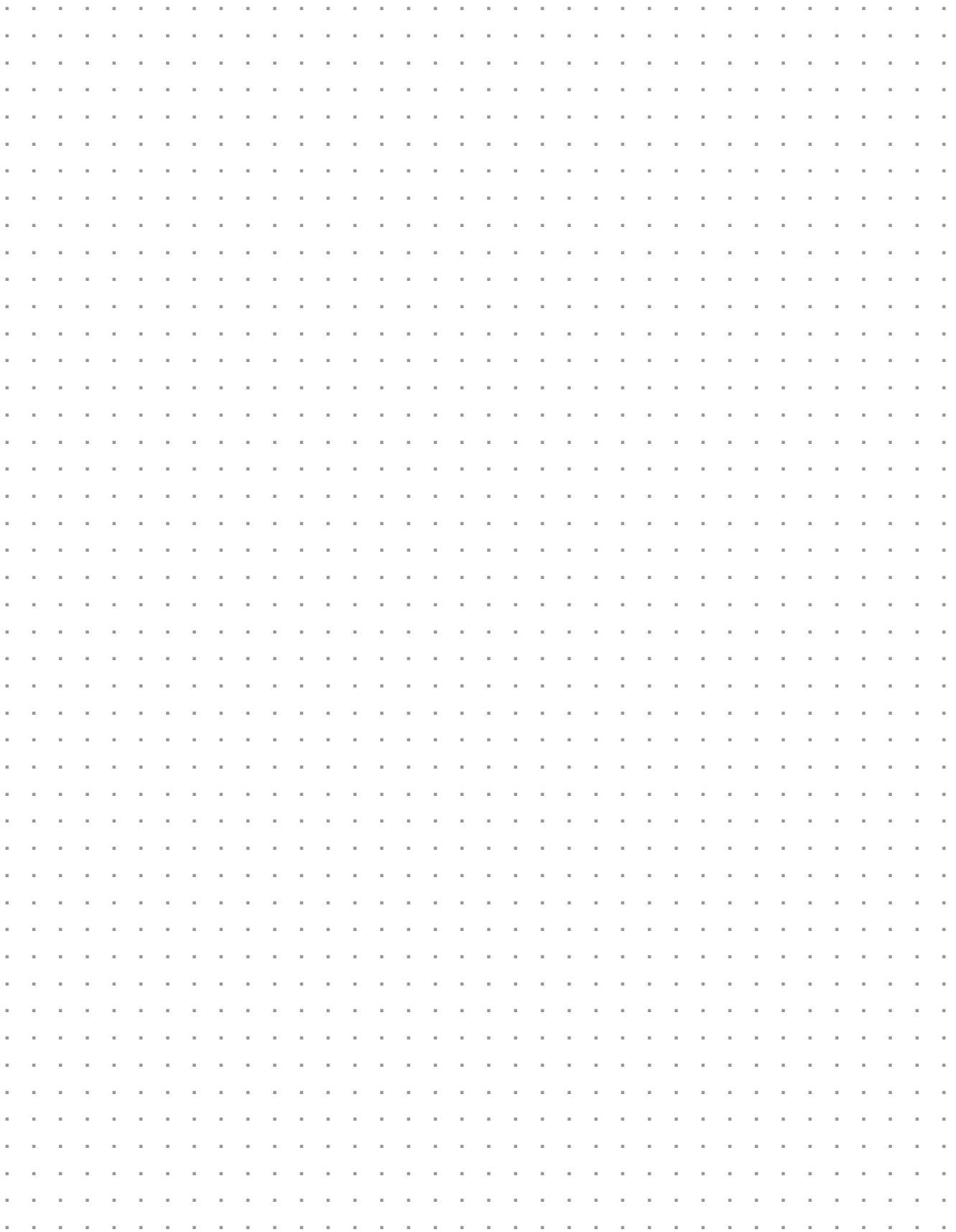

A large grid of small dots for taking notes, covering the majority of the page area.

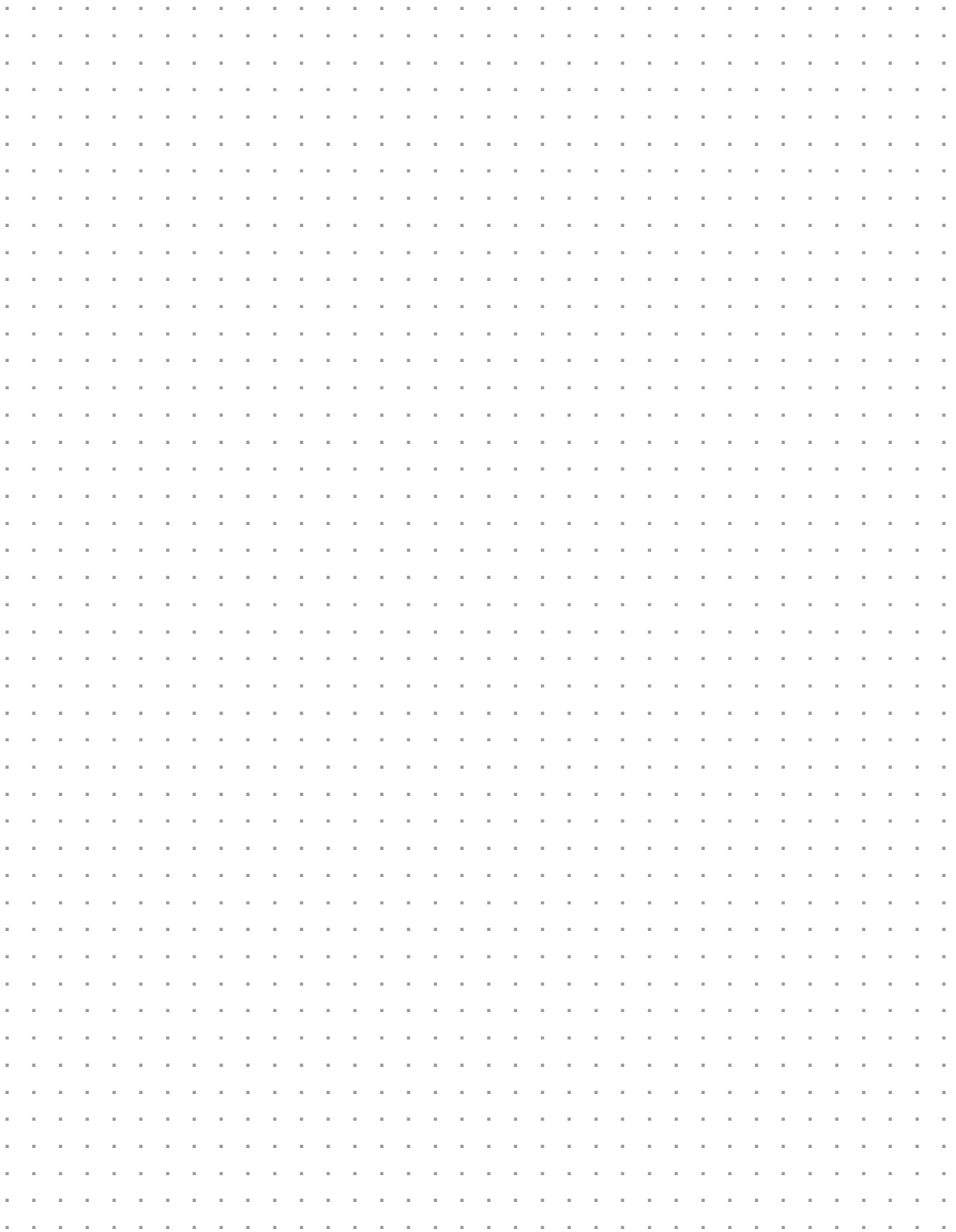

Impressum:

Layout/Satz/Abwicklung: © wurster medien · Werbeagentur für digitale Medien, Printmedien & Fotografie · Dornstetten · www.wurster-medien.de

Fotografie: Titel & Produkte © wurster medien · Fotolia.com: © Photocreo Bednarek, © cherezoff, © richterfoto

DE/GB/F_8.2017_9.180.1



ZERTIFIKAT

DIN EN ISO 9001

Die EQM ZERT GmbH bescheinigt hiermit, dass
das Unternehmen

WENDEL tools GmbH

Hofgarten 5
D-72160 Horb am Neckar

mit dem Geltungsbereich:
Herstellung und Vertrieb von angetriebenen und statischen
Werkzeugaufnahmen für Dreh- und Fräszentren

am Standort:
D-72160 Horb am Neckar

ein Qualitätsmanagementsystem entsprechend der Norm DIN EN ISO 9001:2015
eingeführt hat und wirksam anwendet. Der Nachweis wurde im Rahmen
des Audits mit der Bericht-Nr. 40002611 erbracht. Die Zertifizierung
bzw. das Zertifikat hat eine Gültigkeit von 3 Jahren, sofern die jährlichen
Überwachungsaudits in den festgelegten Fristen mit positivem Ergebnis
abgeschlossen wurden.

Zertifizierungs-Nr.: 4000217611
Ausstellungsdatum: 13.03.2017
Gültig bis: 12.03.2020



Dieses Dokument ist Eigentum der EQM ZERT GmbH
EQM ZERT GmbH - Pöfelerkolon 5 - 80330 München -
www.eqm-zert.de

European Quality Management
EQM ZERT GmbH

Wir sind zertifiziert
nach DIN EN ISO 9001.

We are certified to
DIN EN ISO 9001.

